



TiTan™ 300L Ion Pump



TECHNICAL SPECIFICATIONS

Element Type	CV/CVX	DI/DIX	TR
Pumping Speed (l/s, Nitrogen)	300	240	240
Starting Pressure (mbar)	$\leq 1 \times 10^{-3}$	$\leq 1 \times 10^{-3}$	$\leq 5 \times 10^{-2}$
Lifetime (hours @ 10^{-6} mbar)	50,000	50,000	80,000
Ultimate Pressure (mbar)	$< 1 \times 10^{-11}$		
Maximum Baking Temperature (°C)	250 / 450 (without magnets)		
Inlet Flange	DN 150 (8 in.) CFF		
Weight, kg (lbs)	66 (145)		

DIMENSIONAL DETAILS*

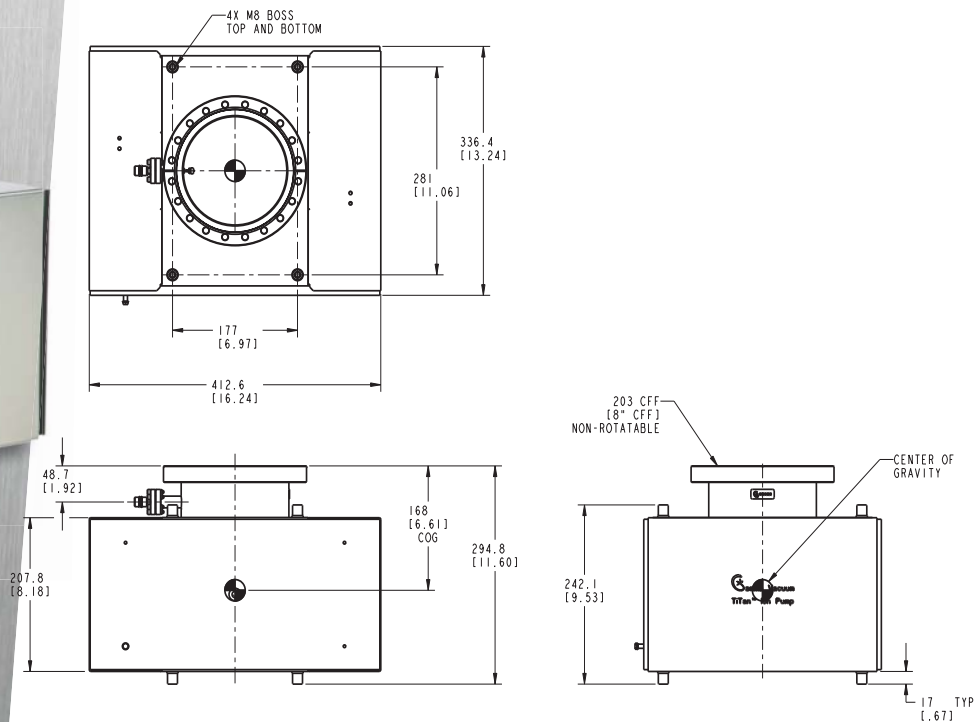

*Single inlet flange shown. Alternative configurations available at www.gammavacuum.com