



Feedthroughs – electrical and optical

6 The feedthrough product line	250	6.5 Power feedthroughs	350
Introduction	250-253	Introduction	350-351
6.1 Multi-pin feedthroughs	254	Power – Low	352-359
Introduction	254-255	Power – Medium	360-367
500V / 3.5A	256-257	Power – High	368-387
700V / 10A / single ended	258-259	Power – Water-cooled	388-395
700V / 10A / double ended	260-261	Powerglove	396-405
700V / up to 10A	262-263	RF Power feedthroughs	406-411
12,000V / 7.5A / 7 pins	264-265	6.6 Fluid feedthroughs	412
Subminiature-C	266-267	General purpose	413-415
Subminiature-D	268-269	Liquid nitrogen	416-418
6.2 Coaxial feedthroughs	270	6.7 Breaks and envelopes	419
Introduction	270-273	Introduction	419
BNC Grounded shield / single and double ended	274-277	Cryogenic and liquid	420-421
BNC Floating shield / single and double ended	278-279	Vacuum breaks to 15,000V	422-424
MHV Grounded shield / single and double ended	280-283	Vacuum envelopes to 40,000V	425
MHV Floating shield / single and double ended	284-285	6.8 Connectors and cables	426
SHV-5 Exposed and recessed	286-289	Introduction	426-429
SHV-10 Exposed and recessed	290-293	Circular and MS connectors	430-434
SHV-20 Exposed and recessed	294-297	Coaxial	434-441
SHV-B 7500V / 3A	298-299	Microdot®	442
Type-N single and double ended	300-301	Thermocouple	443-445
SMA Single and double ended	302-303	In-vacuum	446-450
SMA High frequency	304-305	Subminiature	451-453
Microdot® grounded shield / single ended	306-307	Wires, cables and insulators	454-461
Between series	308-311	Braid and plate	462
6.3 Fibre optics – feedthroughs	312-313	Wire and rod	463
6.4 Thermocouple feedthroughs	314	In-vacuum wiring	464-467
Introduction	314-315	Fibre optics – Cables and couplers	468
Miniature connectors	316-325	Insulators and spacers	469
Screw type connectors	326-335	Tools and safety equipment	470-471
MS Connectors	336-339		
Push-on connectors	340-341		
TC Power	342-349		

The feedthrough product line

Introduction

Electrical feedthroughs

- Multi-pin
- Coaxial
- Fibre optics
- Thermocouple
- Power
- RF Power
- Breaks and envelopes
- Connectors
- Wires and insulators

Custom engineering

- Custom feedthrough configurations available on request, please contact technical sales.



Electrical Feedthroughs

Multi-pin

instrumentation feedthroughs contain more than one conductor path or pin. These feedthroughs are used for the transmission of signal voltages and currents, They are commonly referred to as instrumentation feedthroughs because of their use in instrumentation control applications.



Type-D subminiature

offers complete air and vacuum multi-pin connectivity solutions. 9, 15, 25 and 50 pin

configurations are hermetically sealed using the latest in glass-ceramic bonding technology. Air-side interfaces are designed to mate with standard off-the-shelf serial cable connectors. Vacuum connectivity is made possible with Caburn-MDC's unique UHV compatible connectors and ribbon cable assemblies.



These instrumentation feedthroughs provide the same conveniences of circular type multi-pin products, but offer higher pin density with smaller footprints.

Type-C subminiature is the latest addition to a comprehensive line of glass-ceramic, hermetically sealed instrumentation feedthroughs. This is a circular geometry nine-pin feedthrough designed for applications where space is at a premium or where conventional subminiature type-D connections will not fit. Its circular geometry allows the installation of this product into very small vacuum flanges.

Fibre optic connectivity for vacuum science and technology is now available in CF metal seal and ISO KF elastomer seal flanges which are fitted with high purity 600µm silica fibres, which are in turn terminated with industry standard SMA connectors. Cable assemblies suitable for service in air and vacuum are available for complete air to vacuum connectivity solutions. These high temperature fibre optic components are ideally suited to UHV service in medical, industrial and research applications. UV and IR grades are included and cover the spectral regions between 180-1200nm and 500-2600nm respectively. The pure synthetic silica core provides very low loss and good immunity to radiation damage. Fibres are coated with a layer of copper metal which gives added strength and high temperature service capabilities. The fibres used in IR feedthroughs and cables offer an extended transmission range when compared to conventional silica fibres. They are commonly referred to as "Dry" or low "OH" silica. Air service cable assemblies come standard with a stainless steel sheath/armour that provides excellent fibre protection. Each end is terminated with a knurled SMA hand nut for quick and convenient connection. In-vacuum cable assemblies are not armoured.

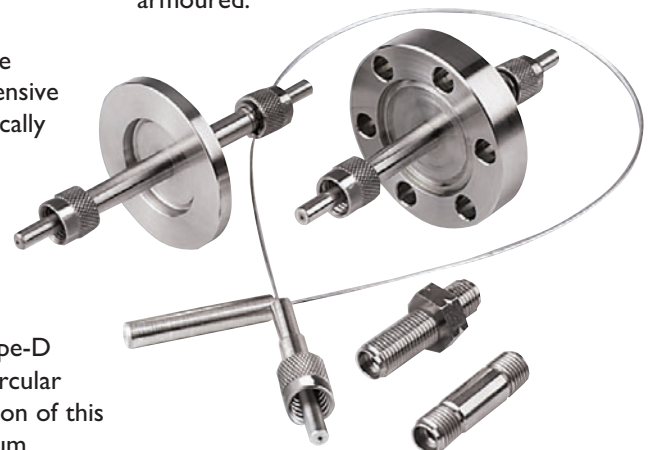

All dimensions are nominal in millimetres unless specified

The feedthrough product line

Introduction

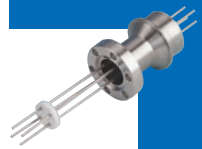

Coaxial feedthroughs are those products constructed with two concentric conductor paths. One outer metal tube or shield path, concentric with, and enclosing, a cylindrical centre conductor path. The inner and outer paths are separated and insulated with a high purity alumina ceramic. Coaxial components are offered for industry standard BNC, MHV, SHV, type-N, SMA, SMB, Microdot®, between series, SHV Bakeable and Type-D subminiature connector interfaces. Coaxial style feedthroughs for almost any application, from instrumentation signals to 20kV high voltage power are included.

Thermocouple feedthroughs are used in applications for in-vacuum temperature measurement. A thermocouple is a device that measures temperature as a function of the electromotive force induced when heat is applied to two dissimilar metal wires, which are joined at both ends. Caburn-MDC thermocouple feedthroughs are not temperature sensing devices as such, but matched components used to conduct a thermocouple's voltage (EMF) through the bulkhead of a chamber to external instrumentation. Caburn-MDC offers base, refractory and noble metal compatible feedthroughs with various connector options including miniature, circular MS, push-on and screw-type connectors.

Power feedthroughs are used to transmit either high voltage, high current or a combination of both. These can be used for a multitude of vacuum applications including vacuum furnaces, sample heating or biasing, in-vacuum coating applications such as electron beam evaporation, resistive heating evaporation, and DC plasma sputtering. Proven and time-tested designs are used to optimize the electrical performance of Caburn-MDC power

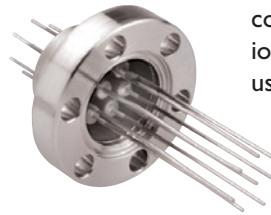

feedthroughs. Where space is not a limitation, ceramic surfaces are made as long as possible to maximize strike and creep distances. If space is limited, ceramics are convoluted in order to achieve increased surface distances with minimal impact on an insulator's overall length. All air-side ceramic surfaces are glazed with a high-temperature glass coating that reduces ceramic surface roughness and minimizes surface contamination. This glass coating enhances a ceramics' electrical surface tracking characteristics. Some Caburn-MDC power feedthroughs are fitted with tubular conductors that can be used to transmit both power and coolant simultaneously. These products are referred to as water-cooled feedthroughs.



Water-cooled electrical components are typically used with grounded, closed-loop cooling systems and non-conductive coolants such as de-ionized water or ethylene glycol. If using plain tap water, the cooling system must be grounded and lines must employ non-conductive materials such as polypropylene tubing.

Properly grounded water lines will provide a safe dissipation path for any power conducted by the water. Current or power ratings are usually not given for water-cooled feedthroughs as the ratings are dependent on coolant flow rates and their heat dissipating capacity. Tap water temperatures can vary dramatically from one region to another, so too will its heat dissipating capacity. Users are advised to establish safe and practical coolant flow rates based on the power requirements for their specific application and coolant heat dissipation capacity.

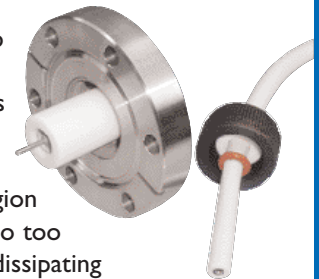

All dimensions are nominal in millimetres unless specified



Section 6.1

The feedthrough product line

Feedthroughs – electrical and optical

Introduction

PowerBoot™ are high voltage silicone connectors. They can be used to carry high voltage, high current or a combination of both. PowerBoot™ feedthroughs are designed for use with these connectors. PowerBoot™ feedthroughs are used in a multitude of applications including vacuum furnaces, sample heating, biasing and in-vacuum coating applications. The PowerBoot™ products are ideally suited for electrically challenging atmospheric environments.

Breaks and envelopes are tube-like adaptors with metal tube hardware bonded to the ends of a ceramic tube. The bonded metal tube ends provide a means of attaching the breaks and envelopes to vacuum tube lines using flange mounts or welding. The central ceramic portion of a break or envelope provides electrical insulation between the two conductive metal ends. In other words, the ceramic produces an electrical break in an otherwise continuous and conductive metal tube geometry.

Electrical connectors are an essential accessory for the user of electrical feedthroughs as power must be transmitted between the application within the vacuum and the external or air-side

instrumentation. Caburn-MDC offers a wide variety of electrical connectors for service in air or vacuum environments. Most connectors featured are either included or used with the standard electrical feedthroughs in this catalogue. Please refer to specification tables for general characteristics of each connector and refer to the relevant page numbers where full descriptions, recommendations and wiring instructions may be found.

In-vacuum coaxial cables

are available in various styles and configurations. All are constructed with vacuum grade materials and components, including stainless steel braided shielding, high purity alumina ceramic or Kapton® insulation, beryllium copper contacts and aluminium or stainless steel terminations. These cable assemblies are suitable for high temperatures and rated for high and ultrahigh vacuum service.

A wide variety of bare wire, rod and tube materials, all of which are suitable for high and ultrahigh vacuum applications are also offered. Special purpose materials such as stainless steel braided shielding and Glidcop® copper alloy wire, insulated with fish spine alumina ceramic beads are ideal for the fabrication of flexible, vacuum ready coaxial cables. Also available are thermocouple wire and rod materials.

Thermocouple wire types C, E, J, K, R, S, T and N are supplied as matched pairs. Type C, R, and S are supplied in extension grades only.

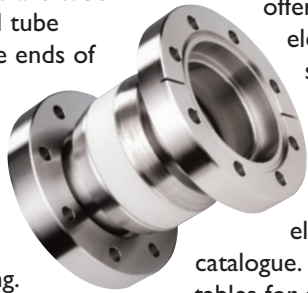

All dimensions are nominal in millimetres unless specified

The feedthrough product line

Introduction



Insulators and spacers are fabricated using high purity alumina which is ideal for high and ultrahigh vacuum service. Alumina is a multi-crystalline form of sapphire and its properties include high compressive and mechanical strength, high wear and heat resistance, good radiation resistance and high electrical resistivity. It also has zero porosity and is hence impervious to all gases. All of these properties make alumina an excellent engineering material suitable for some of the most extreme and demanding applications. Shielded ceramic stand-offs are an ideal solution for the routing of high voltage power lines inside a vacuum system. Bare conductor power lines can be safely and conveniently fastened to a vacuum chamber walls. The shielded ceramic construction makes these stand-offs ideally suited for use in vacuum coating environments where deposition onto ceramic surfaces is not desirable.

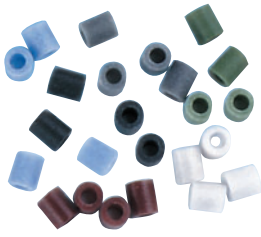

Custom engineering

At Caburn-MDC we know that many of tomorrow's standard components will evolve from the special fabrications produced today and to this end we listen all the more carefully to our customer's individual requirements. The custom engineering of ceramic-to-metal seals is a central part of our manufacturing activity. Our sales teams are always available to discuss technical issues.

Ceramic-to-metal ratings

Temperature

The joining of ceramics to metals is a compromise between materials with dissimilar expansion coefficients. Low expansion metals combined with careful joint design bring expansion coefficients within an acceptable match and effectively minimize the stresses caused by differential expansion between the ceramic and metal components being bonded. Minute variations in expansion coefficients can be detrimental when ceramic to metal seals are subjected to severe thermal gradients. Please note that the maximum recommended thermal gradient for any ceramic-to-metal seal should not exceed 25°C per minute.

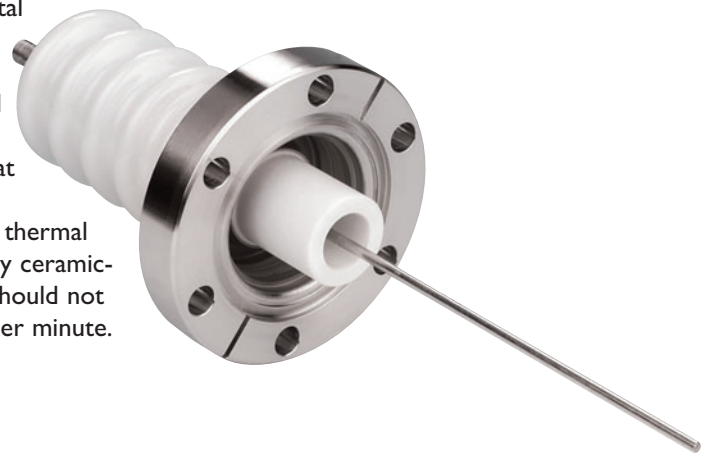

Electrical

The electrical feedthroughs offered in this catalogue are electrically rated for operation with one side in dry atmospheric conditions while the opposite end is in a stable vacuum environment with a maximum system pressure of 1.3×10^{-4} mbar. We recommend that users make allowances for deviations from these stated operating parameters and take adequate safety precautions when working with high voltages or currents.

Dimensional information

Dimensions depicted herein are for reference only. Tolerances will vary by specific product line and will depend on various geometric parameters. Please consult with technical sales for applications requiring specific tolerances.

All dimensions are nominal in millimetres unless specified

Multi-pin feedthroughs

Introduction



Multi-pin is the classification given by Caburn-MDC to all feedthrough products containing one or more conductor pins, which are also fitted with air or side threaded connectors.

Multi-pin feedthroughs are commonly used for the transmission of electrical signals and/or low power applications. They are typically referred to as instrumentation feedthroughs, because of their use in instrumentation applications such as electron microscopy, surface analysis and semiconductor process controls.

Circular connectors

3 to 7 pins, were developed for applications requiring moderate pin density while maintaining relatively small package size. These products are fitted with dependable, screw type air-side connectors.

MS circular connectors

4 to 35 pins, were developed for similar purposes, but fitted with industry standard threaded connectors, which meet MIL-C-5015 specifications. These feedthroughs are offered with electrical ratings up to 1750V and 23A.

Subminiature-C

Subminiature-C, the latest addition to a comprehensive line of glass-ceramic, hermetically sealed instrumentation feedthroughs. This is a circular geometry 9-pin feedthrough designed for applications where space is at a premium or where conventional Subminiature type-D connections will not fit. Its circular geometry allows the installation of this product into very small vacuum flanges including the popular DN16CF metal seal flange as well as ISO KF16 elastomer seal quick-style flanges. Nine gold plated pins are hermetically sealed and electrically insulated in a stainless steel shell using the latest in glass-ceramic bonding technology. Each kit is supplied with an air-side cable assembly including connectors. Subminiature-C air and vacuum-side connectors are fitted with captured stainless steel socket head screws which provide a means of securely locking them to their mating feedthroughs.

All in-vacuum connector screws are vented where required. The feedthroughs mating-screw boss doubles as a polarizing key. Air to vacuum pin positions are identified with a permanent surface indentation to facilitate the pin assignment operation.

Subminiature-D

Type-D subminiature feedthroughs are high density multi-pin instrumentation feedthroughs constructed with pin arrangements designed to meet MIL-C-24308 specifications. 9, 15, 25 or 50 gold plated pins are hermetically sealed and electrically insulated in a stainless steel shell using the latest in glass ceramic bonding techniques. Additional units may be purchased as stand-alone items. For vacuum-side connections a Kapton[®] insulated in-vacuum ribbon cable and PEEK material Type-D connectors meet the rigorous demands of UHV environments. In-vacuum cables and connectors are not included with the feedthrough assembly and must be purchased separately.

Intended operating conditions

Electrical ratings are determined by various factors, including dielectric strength, geometry and system operating pressure. Please note that all the products in this catalogue are electrically rated for operation with one side in dry atmospheric conditions and the other side in a vacuum environment with a maximum system pressure of 1×10^{-4} mbar. We advise that users make allowances for deviations from stated operating parameters and take adequate safety precautions when feedthroughs are operated at high voltages or high currents.

UHV and HV series

Caburn-MDC offers three standard vacuum mount styles: CF, ISO KF and weldable. Additional configurations are available upon request.

All dimensions are nominal in millimetres unless specified

Multi-pin feedthroughs

Introduction



General specifications

Type	Specification voltage/current per pin	Maximum bakeout temperature	Conductor materials	Number of pins	Maximum current All pins loaded
Multi-pin 	500V DC 3.5A	CF Flange 450°C ISO KF flange 150°C Weldable 450°C Connector 65°C	Molybdenum	3, 5 and 7	3 pins – 6A 5 pins – 10A 7 pins – 15A
MS Multi-pin Single ended 	700V DC 10A	CF Flange 450°C ISO KF flange 150°C Weldable 450°C Connector 65°C	Alumel	4 to 35	4 pins – 28A 6 pins – 36A 10 pins – 50A 20 pins – 75A 35 pins – 100A
MS Multi-pin Double ended 	700V DC 10A	CF Flange 450°C ISO KF Flange 150°C Weldable 450°C Air-side connector 350°C Vacuum-side connector 350°C	Alumel	4 to 35	4 pins – 28A 6 pins – 36A 10 pins – 50A 20 pins – 75A 35 pins – 100A
MS Multi-pin High current 	700V 15 or 23A	DN40CF flange 450°C Connector 125°C	Copper or nickel	2 to 8	Not critical
Sub-C Instrumentation 	300V Low amps	CF Flange 250°C ISO KF 150°C Air-side connector 60°C Vacuum-side connector 250°C	Ni-Fe alloy Gold plated	9	Instrumentation signal voltage and currents
Sub-D Instrumentation 	300V Low amps	CF Flange 250°C ISO KF 150°C Air-side connector 60°C Vacuum-side connector 250°C	Ni-Fe alloy Gold plated	9, 15, 25, and 50	Instrumentation signal voltage and currents

All dimensions are nominal in millimetres unless specified

Section 6.1

Multi-pin

500V / 3.5A

Feedthroughs – electrical and optical



Features

- For instrumentation applications requiring moderate pin density
- UHV compatible materials
- 3 to 7 pins
- Air-side connector included
- 3 standard vacuum mounting styles
- Custom feedthrough configurations available upon request

Specifications

Voltage ¹	500V DC maximum
Current	3.5A per pin
Maximum, all pins loaded:	
3 pins	6A
5 pins	10A
7 pins	15A

Material

Flanges	304ss
Shell	Stainless steel
Pins	Molybdenum
Insulation	Alumina ceramic

Vacuum range UHV/HV 1×10^{-10} mbar / 1×10^{-8} mbar

Temperature range²

CF Flange mounted feedthrough	-50°C to 450°C
ISO KF flange mounted feedthrough	-20°C to 150°C
Weldable feedthrough	-50°C to 450°C
Air-side connector	-50°C to 65°C

¹ Electrical ratings are safe operating limits

² Overall assembly ratings must be adjusted to that of the lowest rated component

UHV and HV series

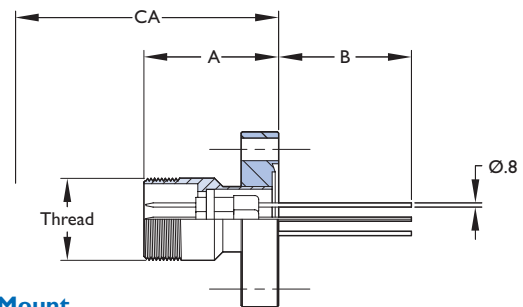

CF Mount

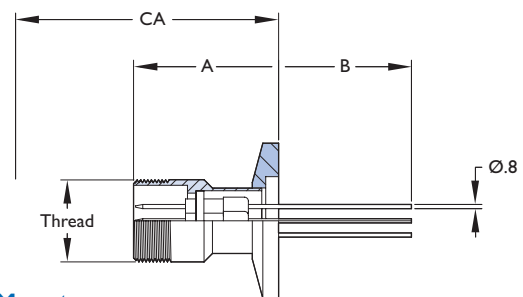

KF Mount

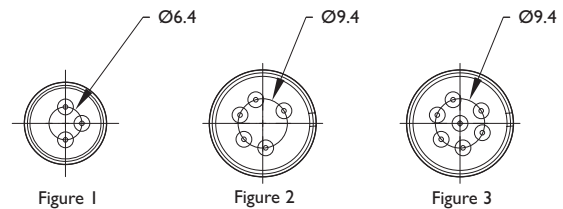
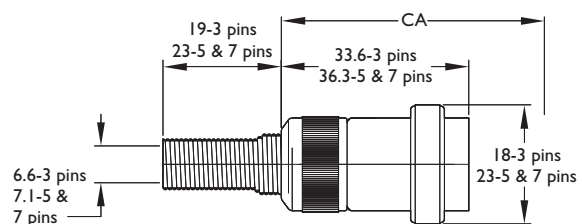

Figure 3 Air side



Air side connector

See intended operating parameters in introductory section

All dimensions are nominal in millimetres unless specified



CF



No. of pins	Flange mount	End view figure	A	B	Thread	CA	Reference	Part number
3	DN16CF	1	26	50	5/8"-27	52	IFM3-C16	9112000
5	DN16CF	2	34	40	13/16"-27	52	IFM5-C16	9112001
5	DN40CF	2	23	52	13/16"-27	52	IFM5-C40	9112002
7	DN16CF	3	34	40	13/16"-27	52	IFM7-C16	9112003
7	DN40CF	3	23	52	13/16"-27	52	IFM7-C40	9112004

Air-side connector included at no extra cost

ISO KF



No. of pins	Flange mount	End view figure	A	B	Thread	CA	Reference	Part number
3	DN16KF	1	27	48	5/8"-27	64	IFM3-K16	9113000
3	DN40KF	1	25	51	5/8"-27	51	IFM3-K40	9113001
5	DN16KF	2	34	40	13/16"-27	64	IFM5-K16	9113002
5	DN40KF	2	21	53	13/16"-27	51	IFM5-K40	9113003
7	DN16KF	3	34	40	13/16"-27	64	IFM7-K16	9113005
7	DN40KF	3	21	53	13/16"-27	51	IFM7-K40	9113006
7	DN50KF	3	21	53	13/16"-27	51	IFM7-K50	9113007

Air-side connector included at no extra cost

Weldable



No. of pins	Weld dia.	End view fig.	A	B	C	D	E	Thread	CA	Reference	Part number
3	12.7	1	51	12.6	9.6	0.6	.51	5/8"-27	52	IFM3	9111000
5	19.05	2	21	53	19	8.9	.9	13/16"-27	63.5	IFM5	9111001
7	19.05	3	21	53	19	8.9	.9	13/16"-27	52	IFM7	9111002

Air-side connector included at no extra cost

All dimensions are nominal in millimetres unless specified



Section 6.1

Multi-pin

700V / 10A / single ended

Feedthroughs – electrical and optical



MS Multi-pin, single ended feedthroughs.

Features

- For instrumentation applications requiring moderate pin density
- UHV-compatible materials
- 4 to 35 pins
- Air-side connector included
- Industry standard threaded connectors
- Three standard vacuum mounting styles.
- Custom feedthrough configurations available upon request

Specifications

Voltage¹ 700V DC maximum

Current 10A per pin

Maximum, all pins loaded:

4 pins	28A
6 pins	36A
10 pins	50A
20 pins	75A
35 pins	100A

Material

Flanges 304ss

Shell Stainless steel

Pins Alumel

Insulation Alumina ceramic

Vacuum range UHV/HV 1×10^{-10} mbar/ 1×10^{-9} mbar

Temperature range²

CF Flange mounted feedthrough -55°C to 450°C

ISO KF flange mounted feedthrough -20°C to 150°C

Weldable feedthrough -55°C to 450°C

Air-side connector -55°C to 125°C

¹ Electrical ratings are safe operating limits

² Overall assembly ratings must be adjusted to that of the lowest rated component

UHV and HV series

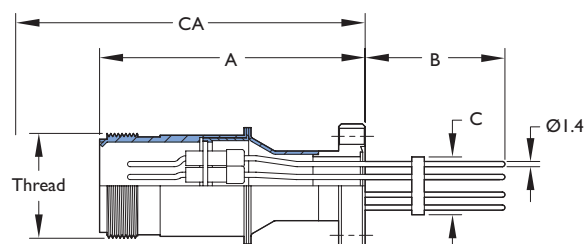

CF Mount

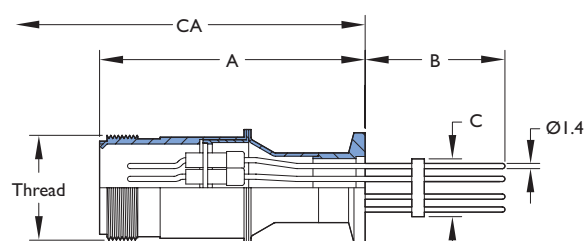

ISO KF Mount

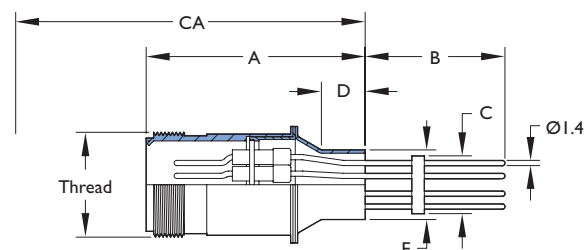

Weldable

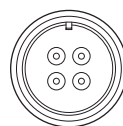

Figure 1

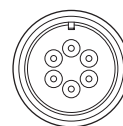

Figure 2

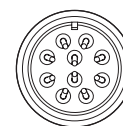

Figure 3

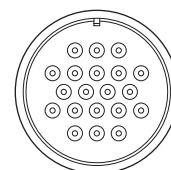

Figure 4

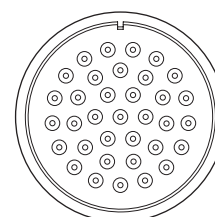
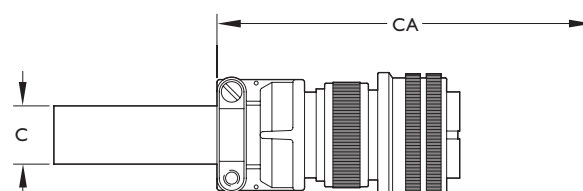

Figure 5

End views Air side



Air side connector

See intended operating parameters in introductory section

All dimensions are nominal in millimetres unless specified



CF



No. of pins	Flange mount	End view figure	A	B	C	Thread	CA	Reference	Part number
4	DN16CF	1	69	69	16	1 1/8"-18	102	IFA4-C16	9132000
4	DN40CF	1	57	80	16	1 1/8"-18	102	IFA4-C40	9132001
6	DN16CF	2	69	69	16	1 1/8"-18	115	IFA6-C16	9132002
6	DN40CF	2	57	80	16	1 1/8"-18	104	IFA6-C40	9132003
10	DN16CF	3	69	69	16	1 1/8"-18	115	IFA10-C16	9132004
10	DN40CF	3	57	80	16	1 1/8"-18	104	IFA10-C40	9132005
20	DN40CF	4	69	88	16	1 3/4"-18	123	IFA20-C40	9132006

Air-side connector included at no extra cost

ISO KF



No. of pins	Flange mount	End view figure	A	B	C	Thread	CA	Reference	Part number
4	DN16KF	1	69	69	16	1 1/8"-18	115	IFA4-K16	9133000
4	DN40KF	1	56	81	16	1 1/8"-18	103	IFA4-K40	9133001
6	DN16KF	2	69	69	16	1 1/8"-18	115	IFA6-K16	9133002
6	DN40KF	2	56	81	16	1 1/8"-18	103	IFA6-K40	9133003
10	DN16KF	3	69	69	16	1 1/8"-18	115	IFA10-K16	9133004
10	DN40KF	3	56	81	16	1 1/8"-18	103	IFA10-K40	9133005
20	DN40KF	4	64	69	16	1 3/4"-18	122	IFA20-K40	9133006

Air-side connector included at no extra cost

Weldable



No. of pins	End view figure	A	B	C	D	E	Thread	CA	Reference	Part number
4	1	60	81	16	12	19	1 1/8"-18	103	IFA4	9131000
6	2	60	81	16	12	19	1 1/8"-18	103	IFA6	9131001
10	3	60	81	16	12	19	1 1/8"-18	103	IFA10	9131002
20	4	64	89	32	19	35	1 3/4"-18	121	IFA20	9131003

Air-side connector included at no extra cost

Accessories



Description	Material	See page	Quantity per pack	Reference	Part number
Crimp	Nickel-200	188	5	TCP-NI	9923018
Ceramic spacer 4/10 pin	Alumina	209	1	CS4/10-2	9951100
Ceramic spacer 6 pin	Alumina	209	1	CS6-2	9951101
Ceramic bead	Alumina	209	85	CB064	9951001

All dimensions are nominal in millimetres unless specified



MS Multi-pin, double ended feedthroughs

Features

- For instrumentation applications requiring moderate pin density
- UHV compatible materials
- 4 to 35 pins
- Air-side and vacuum-side connectors included
- Industry standard threaded connectors
- Standard vacuum mounting style.
- Custom feedthrough configurations available upon request

Specifications

Voltage¹ 700V DC maximum

Current 10A per pin

Maximum, all pins loaded:

4 pins	28A
6 pins	36A
10 pins	50A
20 pins	75A
35 pins	100A

Material

Flanges	304ss
Shell	Stainless steel
Pins	Alumel
Insulation	Alumina ceramic

Vacuum range UHV/HV 1×10^{-10} mbar

Temperature range²

CF Flange mounted feedthrough	-100°C to 350°C
ISO KF Mounted feedthrough	-20°C to 150°C
Weldable feedthrough	-100°C to 350°C
Air/Vacuum-side connector	-100°C to 350°C

¹ Electrical ratings are safe operating limits

² Overall assembly ratings must be adjusted to that of the lowest rated component

UHV Series

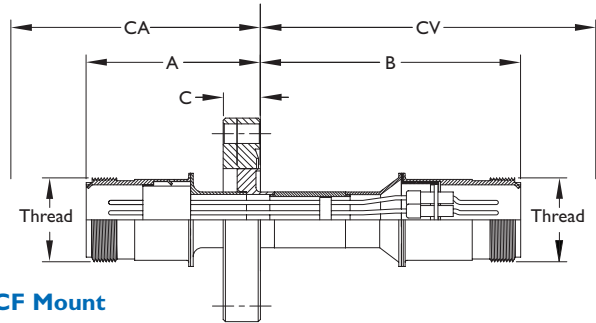

CF Mount

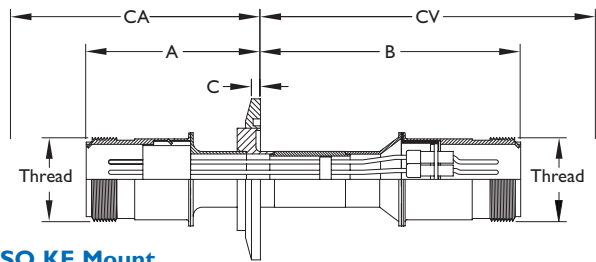

ISO KF Mount

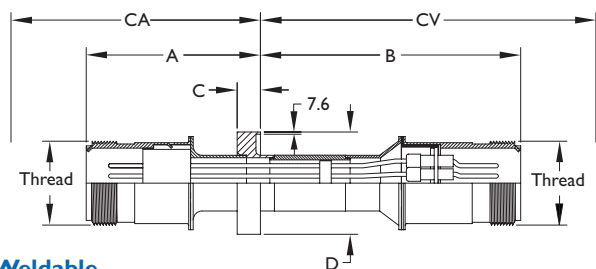

Weldable

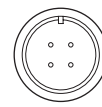

Figure 1

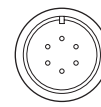

Figure 2

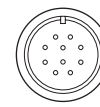

Figure 3

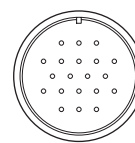

Figure 4

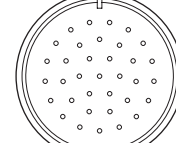
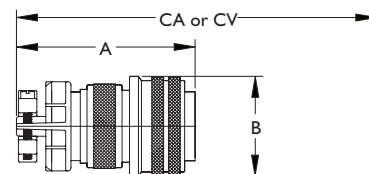

Figure 5

End views Air and vacuum side



Air and vacuum side connector

See intended operating parameters in introductory section

All dimensions are nominal in millimetres unless specified



CF



No. of pins	Flange mount	End view figure	A	B	Thread	CA	CV	Reference	Part number
4	DN40CF	1	61	88	1 1/8"-18	108	134	IFA4D-C40	9132010
6	DN40CF	2	61	88	1 1/8"-18	108	134	IFA6D-C40	9132011
10	DN40CF	3	61	88	1 1/8"-18	108	134	IFA10D-C40	9132012
20	DN63CF	4	72	88	1 3/4"-18	129	129	IFA20D-C63	9132013
35	DN100CF	5	65	98	2 1/4"-16	125	125	IFA35D-C100	9132014

Air-side connector included at no extra cost

ISO KF

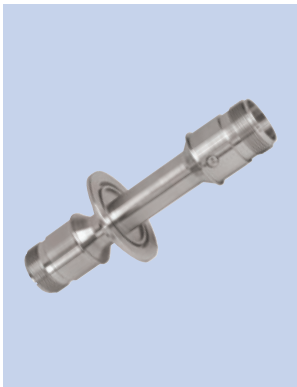

No. of pins	Flange mount	End view figure	A	B	Thread	CA	CV	Reference	Part number
4	DN40KF	1	62	86	1 1/8"-18	109	133	IFA4D-K40	9133009
6	DN40KF	2	62	86	1 1/8"-18	109	133	IFA6D-K40	9133011
10	DN40KF	3	62	86	1 1/8"-18	109	133	IFA10D-K40	9133013

Air and vacuum-side connectors included at no extra cost

Weldable



No. of pins	Weld dia.	End view fig.	A	B	C	D	Thread	CA	CV	Reference	Part number
4	35	1	60	89	8	35	1 1/8"-18	106	135	IFA4D-35	9113005
6	35	2	60	89	8	35	1 1/8"-18	106	135	IFA6D-35	9113006
10	35	3	60	89	8	35	1 1/8"-18	106	135	IFA10D-35	9113007
20	64	4	71	89	10	63	1 3/4"-18	128	146	IFA20D-35	9113008
35	64	5	64	99	10	63	2 1/4"-18	123	158	IFA35D-35	9113009

Air-side connector included at no extra cost

Section 6.1 Multi-pin 700V / up to 23A



Features

- DN40CF Flange mounting
- For high-current applications requiring moderate pin density
- UHV-compatible materials
- 2 to 8 pins
- Air-side connector included
- Industry standard threaded connectors
- Custom feedthrough configurations available upon request

Specifications

Voltage¹	700V DC maximum
Current	15A per nickel pin or 23A per copper pin

Maximum, all pins loaded:
Any number of pins Not critical

Material

Flanges	304ss
Shell	Stainless steel
Pins	Copper or nickel
Insulation	Alumina ceramic

Vacuum range UHV 1x10⁻¹⁰ mbar

Temperature range²

CF Flange mounted feedthrough	-55°C to 450°C
Air-side connector	-55°C to 125°C

¹ Electrical ratings are safe operating limits

² Overall assembly ratings must be adjusted to that of the lowest rated component

UHV Series

CF Mount

Figure 1 Figure 2

Figure 3 Figure 4

Figure 5 Figure 6

Weldable

2 Pin 3 Pin 4 Pin

5 Pin 7 Pin 8 Pin

End views Air side

Air side connector

See intended operating parameters in introductory section

All dimensions are nominal in millimetres unless specified



CF

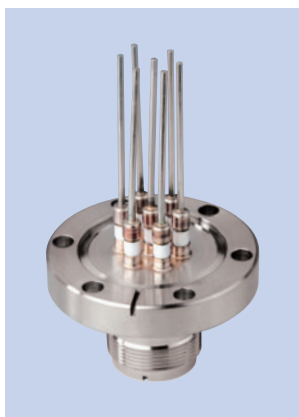

No. of pins	End view figure	A	Conductor material	Amps	Thread	CA	Reference	Part number
DN40CF Flange mount								
2	1	21	Nickel	15	1"-20	86	IFN2-C40	9142001
3	2	25	Nickel	15	1 3/8"-18	94	IFN3-C40	9142003
4	3	25	Nickel	15	1 1/4"-18	94	IFN4-C40	9142005
5	4	27	Nickel	15	1 1/8"-18	94	IFN5-C40	9142007
7	5	25	Nickel	15	1 1/4"-18	94	IFN7-C40	9142009
8	6	33	Nickel	15	1 1/2"-18	100	IFN8-C40	9142011

Air-side connector included at no extra cost

ISO KF



No. of pins	End view figure	A	Conductor material	Amps	Thread	CA	Reference	Part number
DN40CF Flange mount								
2	1	21	Copper	23	1"-20	86	IFC2-C40	9142000
3	2	25	Copper	23	1 1/8"-18	94	IFC3-C40	9142002
4	3	25	Copper	23	1 1/4"-18	94	IFC4-C40	9142004
5	4	27	Copper	23	1 1/8"-18	90	IFC5-C40	9142006
7	5	25	Copper	23	1 1/4"-18	94	IFC7-C40	9142008
8	6	33	Copper	23	1 1/2"-18	100	IFC8-C40	9142010

Air-side connector included at no extra cost

Accessories



Description	Material	Quantity per pack	Reference	Part number
Power-push-on	BeCu	10	PPO-094	9924003
Power in line	BeCu	10	PIL-120	9924006
Ceramic bead	Alumina	56	CB102	9951003

All dimensions are nominal in millimetres unless specified

Multi-pin

12,000V / 7.5A / 7 pins

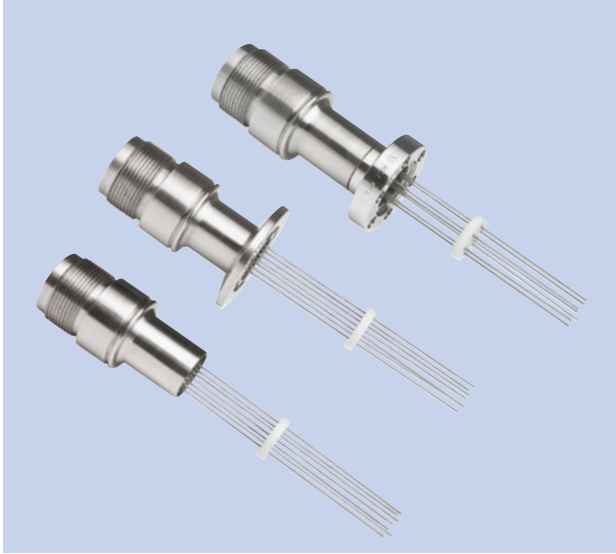

Features

- 7 pin configuration
- For high voltage applications requiring high density pin design
- Industry standard threaded connectors
- Air-side connector included
- 3 standard vacuum mounting styles available
- Custom feedthrough configurations available upon request
- 3 standard styles

Specifications

Voltage ¹	12,000V DC
Current	7.5A/pin
Maximum, all pins loaded:	
7 pin	38A
Material	
Flanges	304ss
Adaptor	304ss
Conductor	Molybdenum
Insulation	Alumina ceramic
Vacuum range UHV/HV	1×10^{-10} mbar / 1×10^{-8} mbar
Temperature range ²	
Feedthrough	-100°C to 450°C
CF Flange mounted feedthrough	-100°C to 450°C
ISO KF Flange mounted feedthrough	-20°C to 150°C
Weldable feedthrough	-100°C to 450°C
Air-side connector	-55°C to 125°C
Dimensions	Reference only, subject to change

¹ See intended operating parameters in introductory section

² Overall assembly ratings must be adjusted to that of the lowest rated component

UHV and HV series

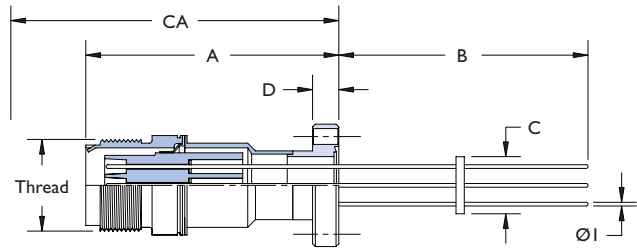

CF Mount

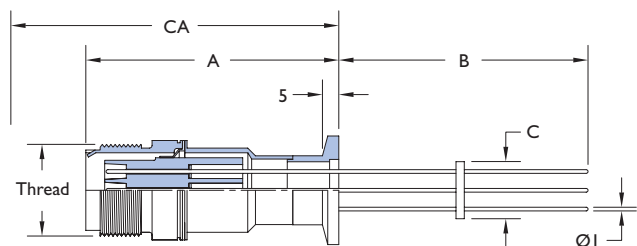

ISO KF Mount

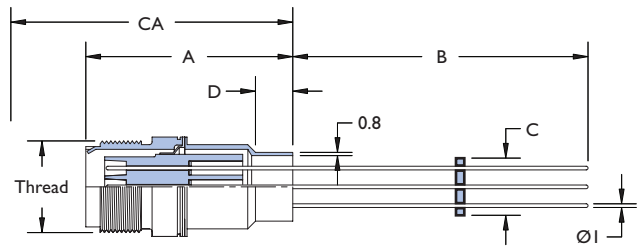

Weldable

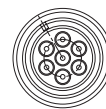

Figure 1

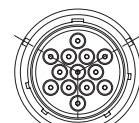
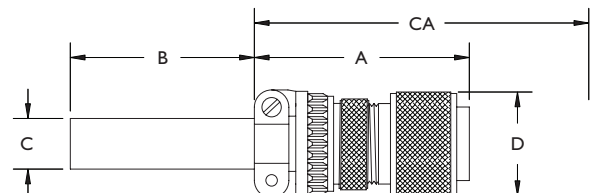
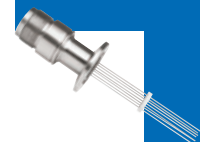

Figure 2

End view Air-side



Connector Air-side



CF



No. of pins	Flange mount	End view figure	A	B	C	D	Thread	CA	Reference	Part number
7	DN16CF	I	70	70	16	7	1-20	93	HV1FM7-C16	9152000
7	DN40CF	I	59	80	16	13	1-20	89	HV1FM7-C40	9152001

Air-side connectors included at no extra cost

ISO KF

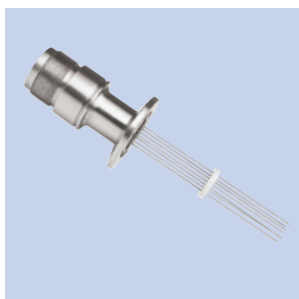

No. of pins	Flange mount	End view figure	A	B	C	Thread	CA	Reference	Part number
7	DN16KF	I	68	71	16	1-20	98	HV1FM7-K16	9153000
7	DN40KF	I	58	85	16	1-20	87	HV1FM7-K40	9153001
7	DN50KF	I	58	85	16	1-20	87	HV1FM7-K50	9153002

Air-side connectors included at no extra cost

Weldable



No. of pins	End view figure	A	B	C	D	Thread	CA	Reference	Part number
7	I	57	82	16	12	1-20	93	HV1FM7	9151000

Air-side connectors included at no extra cost

Description

Subminiature-C, the latest addition to a comprehensive line of glass-to-metal,

hermetically sealed instrumentation feedthroughs. This is a circular-geometry nine-pin feedthrough

designed for applications where space is at a premium or where conventional subminiature type-D connections will not fit. Its circular geometry allows the installation of this product into very small vacuum flanges including the popular DNI6CF metal seal flange, as well as ISO DNI6KF elastomer seal quick-style flanges. Nine gold-plated pins

are hermetically sealed and electrically-insulated in a stainless steel shell using the latest in glass-ceramic bonding technology. Each kit is supplied with both an air and vacuum-side cable assembly including connectors. Subminiature-C air and vacuum-side connectors are fitted with captured stainless steel socket head screws which provide

a means of securely locking them to their mating feedthroughs. All in-vacuum connector screws are vented where required. The feedthroughs mating-screw boss doubles as a polarising key. Air to vacuum pin positions are identified with a permanent surface indentation to facilitate the pin assignment operation.



Feedthrough, cables and connector kit C9
KIT-CI6 shown

Features

- Air-side connectors available
- Vacuum-side connectors available
- Colour coded 9-way Kapton® insulated circular cable
- UHV compatible construction
- Conflat® compatible flanges
- ISO KF compatible flanges
- High-temperature rated to 250°C
- Custom versions on request

Specifications

Voltage¹ 300V DC maximum

Current 5A maximum at 20°C

Material

Shell Stainless steel

Pins Ni-Fe alloy, gold-plated

Seal/insulation Glass-ceramic

Connector, air/vacuum² Delrin®/PEEK®

Vacuum range

UHV/HV 1×10^{-10} mbar / 1×10^{-8} mbar

Temperature range³

Del-Seal™ mounted feedthrough -200°C to 250°C

ISO KF mounted feedthrough -20°C to 150°C

Air-side connector 55° to 80°C

Vacuum-side connector -200°C to 250°C

Dimensions Reference only subject to change

¹ Electrical ratings are maximum test values

Feedthroughs are intended for instrumentation applications carrying low level signal voltages and currents

² PEEK® is a Polyether ether ketone thermoplastic

³ Overall assembly ratings must be adjusted to that of the lowest rated component

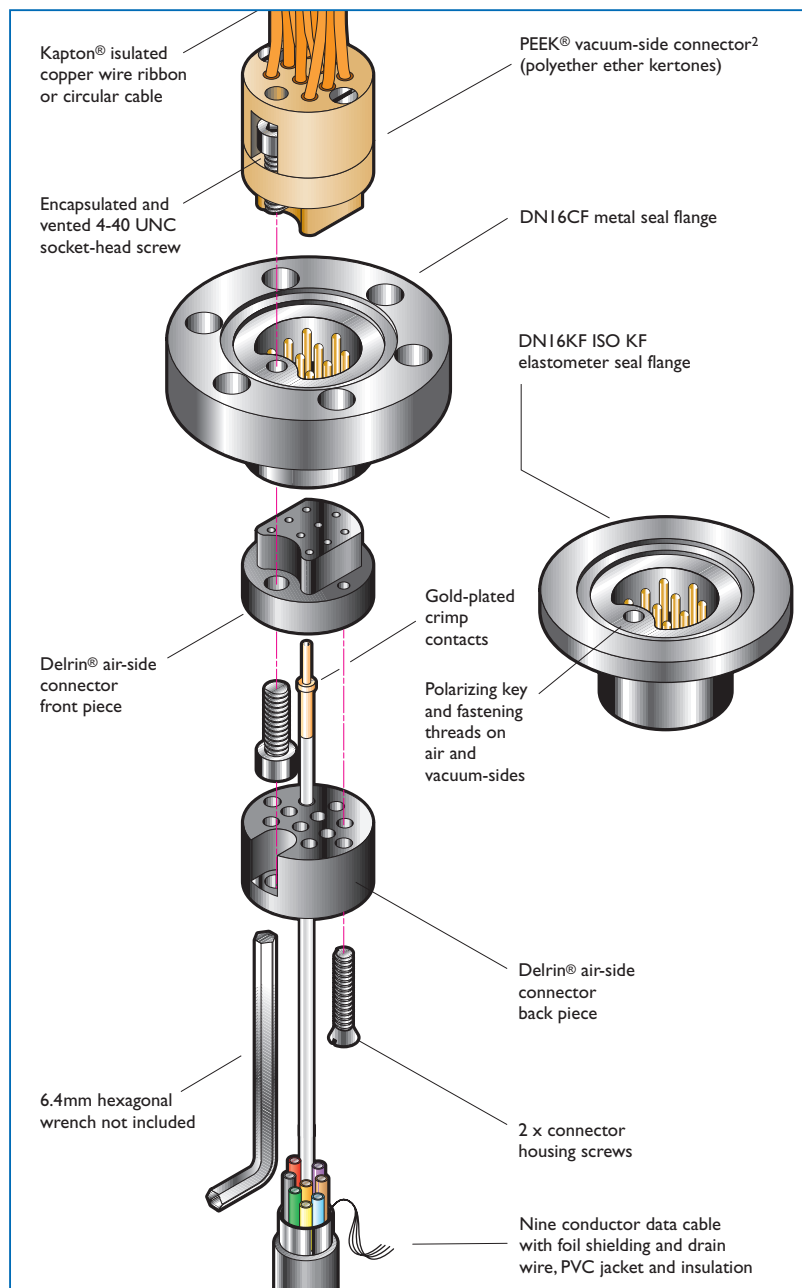

All dimensions are nominal in millimetres unless specified



C9KIT-C16



UHV CF Flange with 9 pins

No. of thread	Flange mount	Reference	Part number
Feedthrough, cables and connectors¹			
9	DN16KF	C9KIT-C16	1512604
Feedthrough²			
9	DN16CF	C9-C16	1512600

¹ Contains air and vacuum-side connectors with 2500mm and 500mm cable lengths respectively

² This is the stand-alone feedthrough and does not include air or vacuum-side connectors

C9-C16

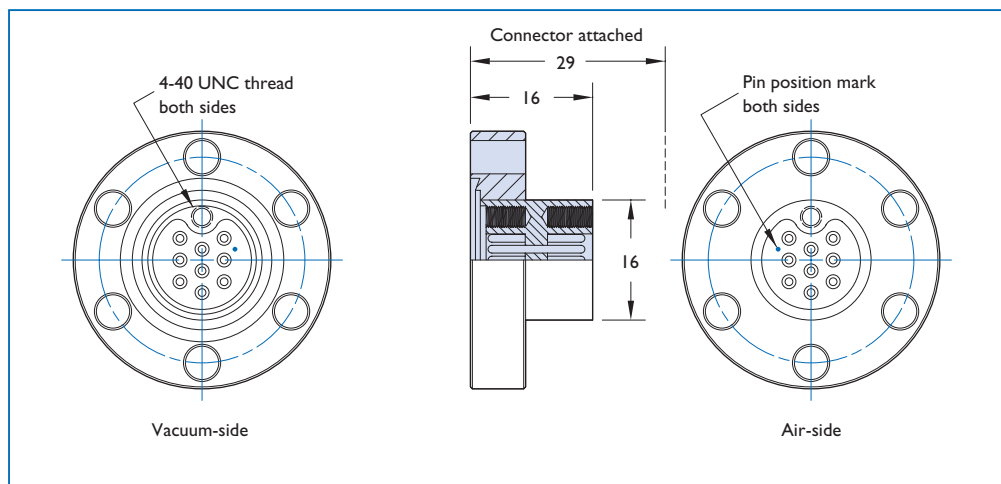

C9KIT-K16



HV ISO KF Flange with 9 pins

No. of thread	Flange mount	Reference	Part number
Feedthrough, cables and connectors¹			
9	DN16CF	C9KIT-K16	1512605
Feedthrough²			
9	DN16KF	C9-K16	1512601

¹ Contains air and vacuum-side connectors with 2500mm and 500mm cable lengths respectively

² This is the stand-alone feedthrough and does not include air or vacuum-side connectors

C9-K16

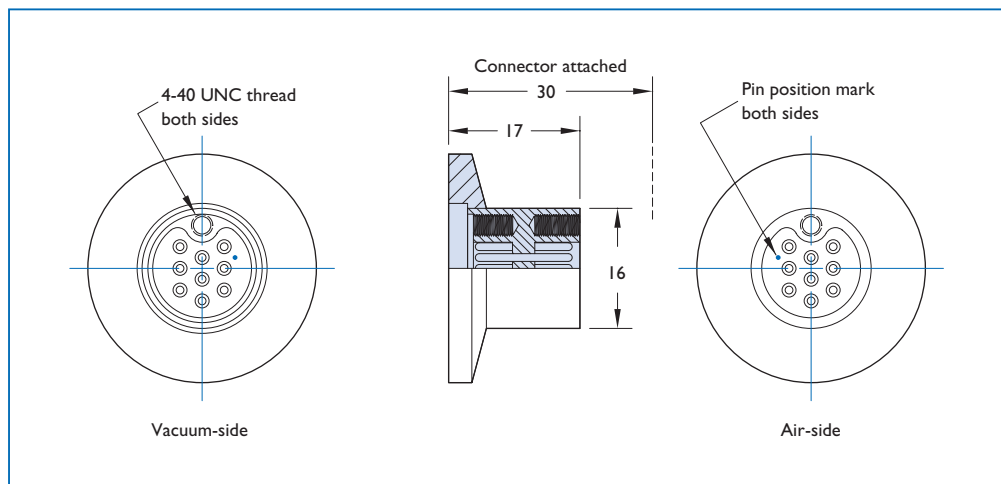

All dimensions are nominal in millimetres unless specified



Custom feedthrough

Features

- Air-side connectors available
- Vacuum-side connectors available
- Kapton® insulated vacuum cables
- UHV compatible construction
- Conflat® compatible flanges
- ISO KF compatible flanges
- High-temperature rated to 250°C
- Custom versions on request

Specifications

Voltage¹ 300V DC maximum

Current 5A maximum at 20°C

Material

Shell Stainless steel

Pins Ni-Fe alloy, gold-plated

Seal/insulation Glass-ceramic

Connector, air/vacuum² Delrin®/PEEK®

Vacuum range

UHV/HV 1×10^{-10} mbar / 1×10^{-8} mbar

Temperature range³

Del-Seal™ mounted feedthrough -200°C to 250°C

ISO KF mounted feedthrough -20°C to 150°C

Air-side connector 55° to 80°C

Vacuum-side connector -200°C to 250°C

Dimensions Reference only subject to change

¹ Electrical ratings are maximum test values

Feedthroughs are intended for instrumentation applications carrying low level signal voltages and currents

² PEEK® is a Polyether ether ketone thermoplastic

³ Overall assembly ratings must be adjusted to that of the lowest rated component

Description

Hermetic subminiature-D feedthroughs are high density multi-pin instrumentation feedthroughs constructed with pin arrangements designed to meet MIL-C-24308 specifications. 9, 15, 25 or 50 gold-plated pins are hermetically sealed and electrically

insulated in a stainless steel shell using the latest in glass-ceramic bonding technology. High and ultrahigh vacuum cable assemblies with PEEK® connectors and Kapton® insulated ribbon cables are available to meet the rigorous demands of UHV environments.

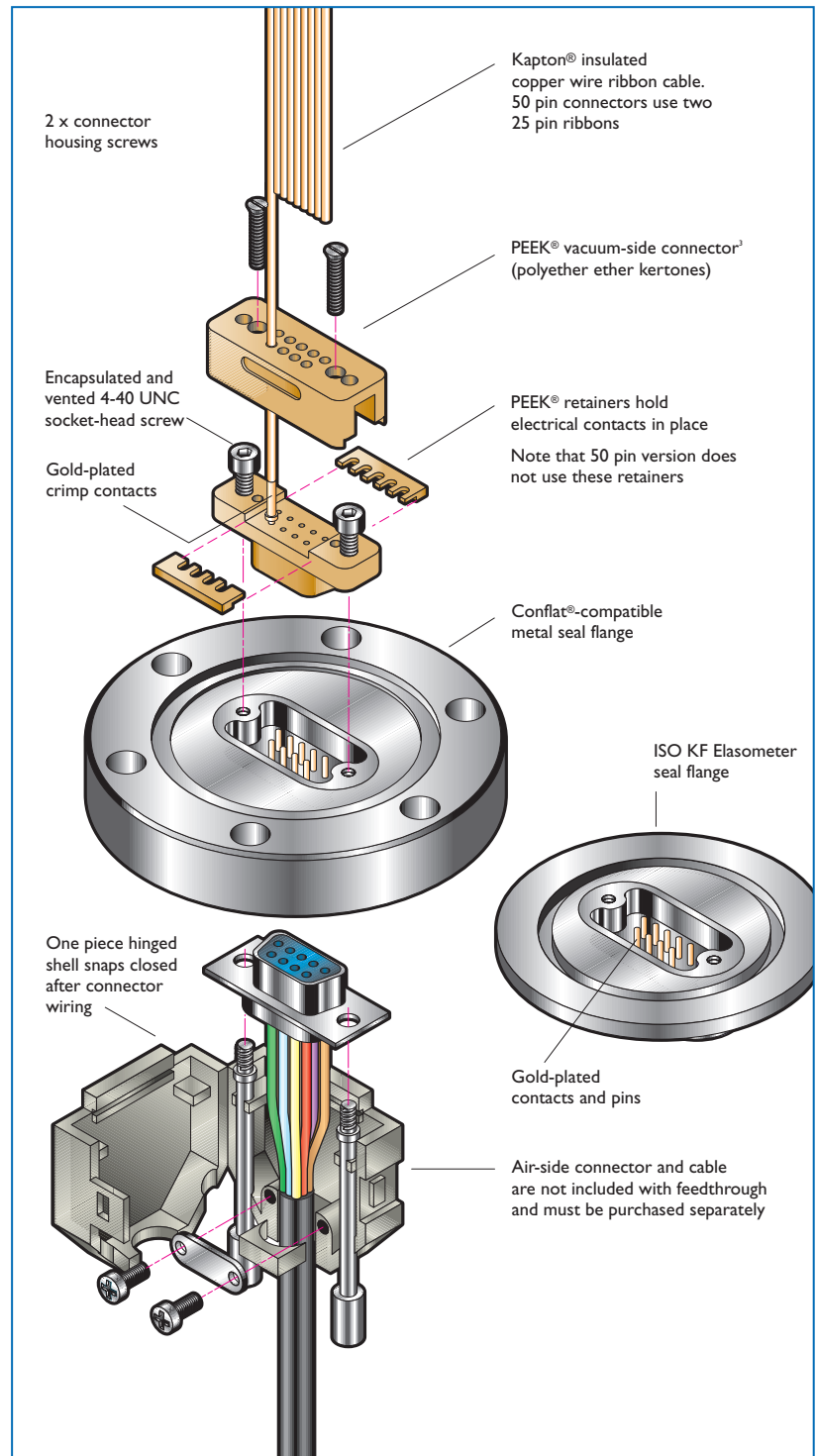

All dimensions are nominal in millimetres unless specified



Vacuum side



UHV CF Flange with 9, 15 25 and 50 pins

No. of pins	Flange mount	A	CA	Reference	Part number
9	DN40CF	15	65	D9-C40	1511000
15	DN63CF	17	69	D15-C63	1511001
25	DN63CF	17	69	D25-C63	1511002
50	DN100CF	20	69	D50-C100	1511007

Caution! Air to vacuum pin positions are reversed because of straight-through pin design

Air-side

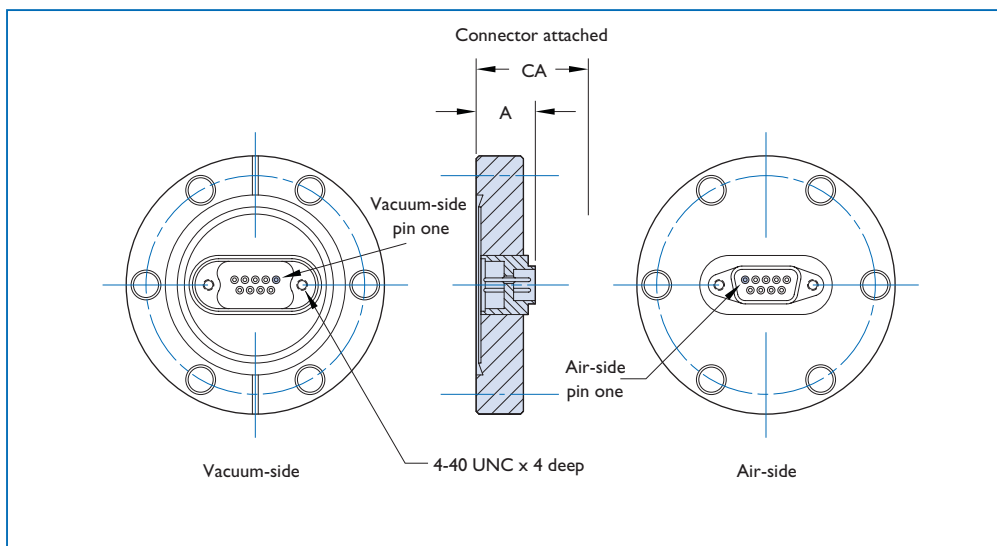

Vacuum side



UHV ISO KF/LF Flange with 9, 15 25 and 50 pins

No. of pins	Flange mount	A	CA	Reference	Part number
9	DN40KF	15	64	D9-K40	1511020
15	DN50KF	15	64	D15-K50	1511021
25	DN63LF	15	64	D25-L63	1511022
50	DN100LF	15	64	D50-L100	1511008

Caution! Air to vacuum pin positions are reversed because of straight-through pin design

Air-side

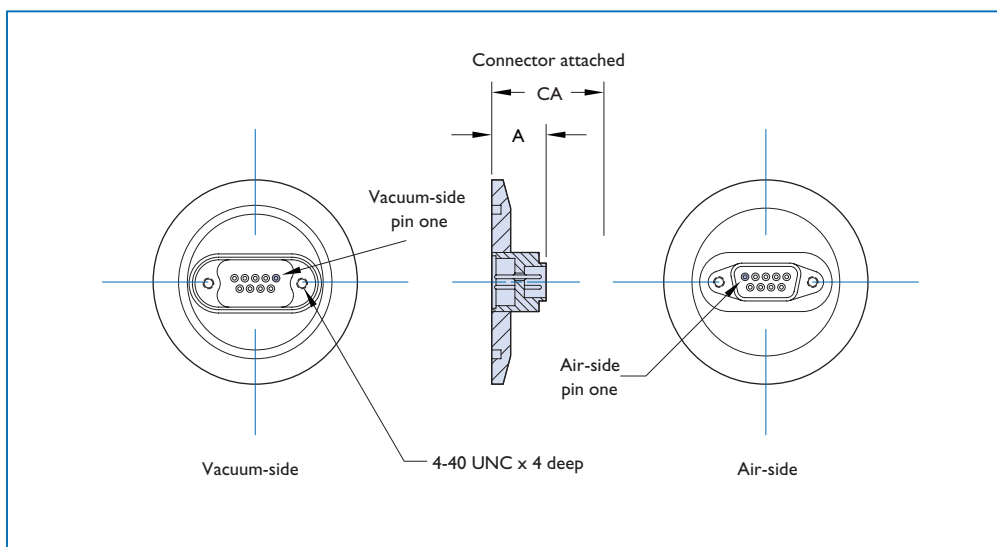

All dimensions are nominal in millimetres unless specified

Coaxial feedthroughs

Introduction

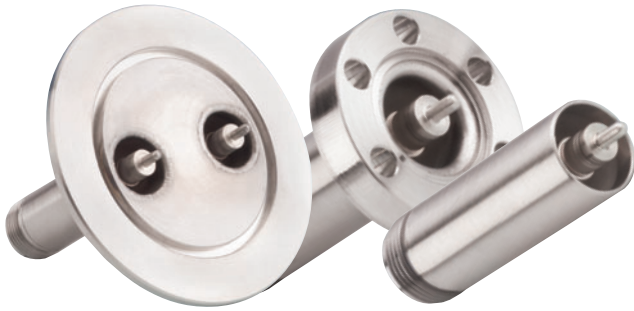

Coaxial is the classification we give all feedthrough geometries containing two concentric conductors – one outer metal tube or shield conductor concentric with, and enclosing, a cylindrical centre conductor. The inner and outer conductors are separated and insulated by an alumina ceramic dielectric. Caburn-MDC's coaxial feedthroughs are available in conventional grounded or floating shield configurations. They are also available in single or double ended geometries and in most cases supplied with industry standard air-side, coaxial connectors.

Single-ended coaxial feedthroughs are used in applications where continuous shielding is not important, or where vacuum space is limited. Double-ended coaxial feedthroughs are used in applications where continuous air and vacuum RF or noise shielding is required.

The significant feature of all coaxial feedthroughs is their concentric geometry. Electrical signals passing through a centre conductor are protected or shielded from external interference or noise by an outer tubular conductor. On the other hand, interference or noise generated by power in the centre conductor is also suppressed by the outer conductor, thus shielding sensitive electronics external to the coaxial line. Floating shield coaxial feedthroughs provide a second shield and dielectric layer, allowing the outer tubular shield to be used as a secondary conductor path. A potential drawback of floating shield feedthroughs is that their ground shields do not completely cover the floating shield or centre conductor, and therefore do not have three concentric and continuously shielded conductor paths.

For cryogenic applications, particular Caburn-MDC coaxial feedthroughs are ideal, due to their seal geometry and material selection. To quickly locate a product suitable for cryogenic use, look for part numbers printed in a light-blue colour. Ceramic-to-metal seals should never be subjected to thermal gradients in excess of 25°C per minute – doing so can greatly reduce the life of the product and void the warranty.

All dimensions are nominal in millimetres unless specified



Part numbers printed in a light blue colour indicate products that are suitable for -200 C cryogenic applications.

Caburn-MDC standard coaxial feedthrough types are as follows:

BNC – Bayonet naval connectors These are generally used in 50Ω and 75Ω low power instrumentation transmission lines. Note that BNC feedthroughs are not impedance rated due to restrictions in geometry and the relatively high dielectric constant of alumina ceramics.

MHV – Miniature high voltage These are similar to BNC series feedthroughs. They do not intermate with BNCs and are used in medium power applications with higher voltage requirements.

SHV-5 – Safe high voltage Like MHV feedthroughs these are rated up to 5000 volts. The difference between these feedthroughs and their MHV counterparts are the pin and contact configuration. SHV cable connectors have recessed female contacts with male mating pins located in the feedthrough. The exact opposite is true with MHV feedthroughs. SHV cable connector centre contacts do not protrude from connector ends as they do on MHVs. This makes them safer in a disconnected condition. SHV feedthroughs are available in four voltage categories and also include industry standard air-side cable connectors.

SHV-10 – Safe high voltage SHV-10 provides an intermediate 10kV solution for SHV coaxial feedthrough applications. The SHV-10 feedthrough complements the standard 5kV and 20kV products currently offered. SHV-10 feedthroughs are ideally suited for high-voltage DC pulsed applications. The outer contact ground connection is maintained throughout the centre contact's mating cycle. The cable connector's centre contact is recessed to prevent shock hazards when the connectors are unmated.

SHV-20 – Safe high voltage SHV-20 feedthroughs and connectors feature special high voltage interfaces which provide reliable service in pulsed high voltage applications. These coaxial feedthroughs are designed for use where the normal operating voltage of standard coaxial connectors is inadequate. The SHV-20 feedthrough was designed to replace the existing SHV-15.

Limitations in its design prevented the SHV-15 from utilizing the full potential of its cable connectors.

The SHV-20 design incorporates an improved electrical interface which includes standard off-the-shelf connector contacts that greatly enhance electrical contact performance. The SHV-20 feedthroughs and connectors cannot be used with older SHV-15 components because contacts and sockets on SHV-20 products use larger pin diameters which will not mate with the older SHV-15 design.



Coaxial feedthroughs

Introduction

**SHV-B – Bakeable safe high voltage**

The difference between these and other SHV feedthroughs is the use of ceramic dielectric material in the air-side cable connectors. Ceramic insulation gives these connectors higher temperature capability than conventional Teflon® insulated products. SHV-B design is not an industry standard connection, but developed for the special requirements of high temperature applications in which connectors can remain engaged and operational at elevated temperatures.

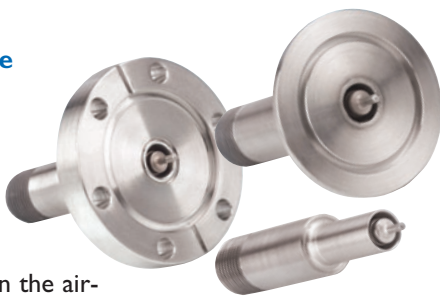

Type-N Type-N coaxial feedthroughs are 50Ω style and suitable for use to 1GHz. Units are designed and rated for high and ultra-high vacuum applications. Except for the nickel conductor units which are non-magnetic and constructed of materials suitable for cryogenic applications.

SMA – Subminiature Type-A SMA-UHV feedthroughs are ideally suited for medium-to-high frequency signal transmission combined with the rigorous demands of ultra-high vacuum environments. The design features of this group will vary, but the double-end SMA includes frequency service to 1GHz, low VSWR low loss and 50Ω matched impedance. For decades the SMA interface has been the connection of choice in accelerator facilities around the world. Caburn-MDC's SMA products have provided reliable service to temperatures as low as -200°C.

High-frequency SMA The high frequency SMA is built similarly to the UHV series SMA, but re-engineered to meet the increasing demands of RF communications system designers. The design parameters of the HF-SMA include high frequency service as high as 8GHz, low VSWR, low loss and 50Ω matched impedance. As a carefully impedance matched component, the HF-SMA offers optimum RF performance. The connector interface is designed in accordance with MIL-C-39012/58F and mates with both industry standard SMA and 3.5mm precision coaxial connectors. In order to achieve these HF performance parameters, the use of Teflon® dielectric spacer material is employed. Although the feedthrough meets the hermetic requirements for UHV environments, it can only be recommended for high vacuum environments where the use of Teflon® is permissible.

SMB – Subminiature Type-B A close relative of the SMA, the SMB interface is also known as subminiature Type-B. Unlike the SMA, the SMB is designed for quick connecting and disconnecting, made possible with its spring retention connector. The SMB products are ideally suited for coaxial applications where space is a luxury. Their small footprint allows for high density arrangements.

Microdot® Caburn-MDC Microdot® style feedthroughs are the smallest threaded interface coaxial connectors available for UHV service. This connector interface has become the standard in the vacuum coating industry. It is widely used in the construction of crystal sensor deposition monitors. This product is complemented by prewired cable assemblies and in-vacuum Microdot® cables and accessories.

BS – Between series coaxial As the name implies, these feedthroughs provide a means of changing coaxial connection styles 'mid-stream'. In the vacuum coating industry, deposition monitors are used to measure the thickness of coatings deposited on a variety of components. The standard connection for these deposition monitors are BNC on air-side and Microdot® on vacuum-side. Throughout this catalogue section, BS coaxial product headings (e.g. BNC-Microdot®), represent respectively the air and vacuum-side connection styles. Other standard options include BNC-A and MHV-A feedthroughs.

Intended operating conditions

Electrical ratings are safe operating limits. These ratings are determined by various factors, including dielectric strength, geometry and system operating pressure. Please note that all products in this catalogue are electrically rated for operation with one side in dry atmospheric conditions and the other side in a vacuum environment with a maximum system pressure of 1×10^{-4} mbar. We

advise that users make allowances for

deviations from stated operating parameters and take adequate safety precautions when

feedthroughs are operated at high voltages or high currents.

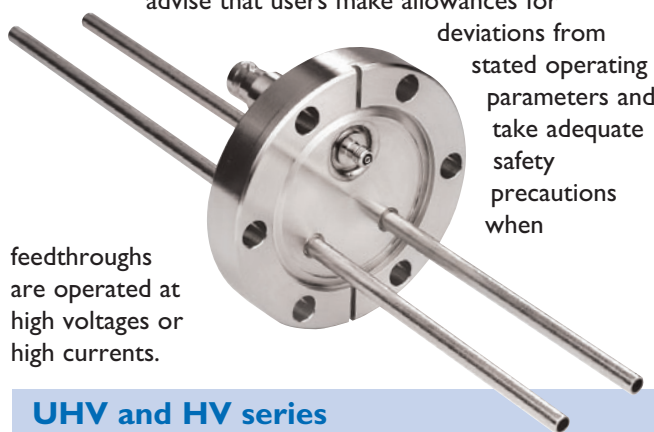
**UHV and HV series**

Caburn-MDC offers three standard vacuum mount styles: CF, ISO KF and weldable. Additional configurations are available upon request.

All dimensions are nominal in millimetres unless specified



Coaxial feedthroughs

Introduction

General specifications

Type	Specification voltage/current	Maximum bakeout temperature	Conductor materials	Impedance rating
BNC 	Ground shield 50V DC Floating shield 2,500V DC 3A	CF Flange 450°C ISO KF Flange 150°C Weldable 450°C Connector 165°C	304 Stainless steel	Non constant
MHV 	Ground shield 5,000V DC Floating shield 2,500V DC 3A	CF Flange 450°C ISO KF Flange 150°C Weldable 450°C Connector 165°C	304 Stainless steel	Non constant
SHV-5 	Ground shield 5,000V DC 5A	CF Flange 450°C ISO KF flange 150°C Weldable 450°C Connector 165°C	Nickel	Non constant
SHV-10 	10,000V DC 5A	CF Flange 450°C ISO KF Flange 150°C Weldable 450°C Connector 165°C	Nickel	Non constant
SHV-20 	20,000V DC 15A	CF Flange 450°C ISO KF Flange 150°C Weldable 450°C Connector 165°C	Nickel	Non constant
SHV-B 	7,500V DC 3A	CF Flange 450°C ISO KF Flange 150°C Weldable 450°C Connector 165°C	304 Stainless steel	Non constant
Type-N 	500V DC 3A	CF Flange 450°C ISO KF Flange 150°C Weldable 450°C Connector 165°C	Nickel	Non constant

All dimensions are nominal in millimetres unless specified



General specifications

Type	Specification voltage/current	Maximum bakeout temperature	Conductor materials	Impedance rating
SMA 	Ground shield 700V DC 1A	CF Flange 450°C ISO KF Flange 150°C Weldable 450°C Connector 165°C	304 Stainless steel	50Ω
HF-SMA 	700V DC 5A	CF Flange 450°C ISO KF Flange 150°C Weldable 450°C Connector 165°C	416 Stainless steel	Non constant
Microdot® 	500V DC 2A	CF Flange 450°C ISO KF flange 150°C Weldable 400°C Connector 125°C	Molybdenum	Non constant
BNC-Microdot® 	500V DC 1A	CF Flange 450°C Baseplate 150°C Weldable 450°C	304 Stainless steel	Non constant
BNC/MHV-A 	BNC-A, 500V DC MHV-A, 5,000V DC 3A	CF Flange 450°C Weldable 400°C Connector 165°C	304 Stainless steel	Non constant

All dimensions are nominal in millimetres unless specified

BNC Coaxial

Grounded shield / single ended



Features

- Noise shield for instrumentation transmission
- Bayonet-style threadless connection
- Air-side connector included
- In-vacuum cables available
- Three standard vacuum mounting styles
- Custom feedthrough configurations available upon request

Specifications

Voltage¹ 500V DC maximum

Current 3A

Impedance rating Non constant

Material

Flanges 304ss

Shell 304ss

Pins 304ss

Insulation Alumina ceramic

Vacuum range UHV/HV 1×10^{-10} mbar / 1×10^{-8} mbar

Temperature range²

CF Mounted feedthrough -200°C to 450°C

ISO KF Mounted feedthrough -20°C to 150°C

Weldable feedthrough -200°C to 450°C

Air-side connector -65°C to 165°C

Dimensions Reference only, subject to change

¹ See intended operating parameters in introductory section

² Overall assembly ratings must be adjusted to that of the lowest rated component

UHV and HV series

CF Mount

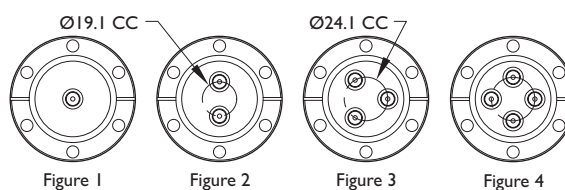
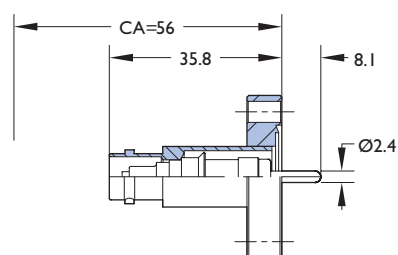

End views Vacuum-side

ISO KF Mount

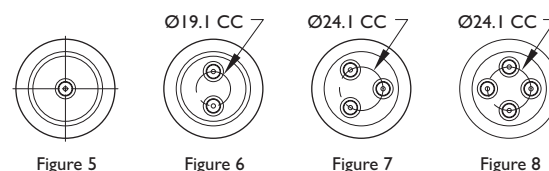
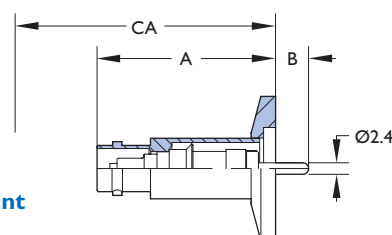

End views Vacuum-side

Weldable

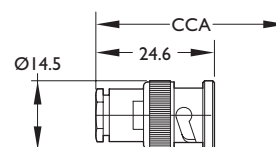
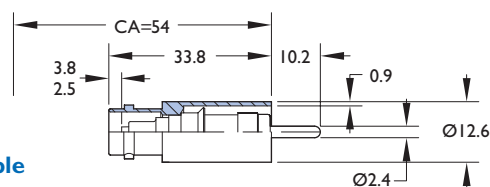

Air-side connector

All dimensions are nominal in millimetres unless specified

BNC Coaxial

Grounded shield / single ended



CF



No. of pins	Flange mount	End view	Reference	Part number
1	DN16CF	1	BNC-C16	9212000
1	DN40CF	1	BNC-C40	9212001
2	DN40CF	2	BNC-2-C40	9212002
3	DN40CF	3	BNC-3-C40	9212003
4	DN40CF	4	BNC-4-C40	9212004

Air-side connector included at no extra cost

ISO KF



No. of pins	Flange mount	End view	A	B	CA	Reference	Part number
1	DN16KF	5	37.1	6.9	57	BNC-K16	9213000
1	DN40KF	5	34.5	9.4	54	BNC-K40	9213001
2	DN40KF	6	34.5	9.4	54	BNC-2-K40	9213002
3	DN50KF	7	34.5	9.4	54	BNC-3-K50	9213003
4	DN50KF	8	34.5	9.4	54	BNC-4-K50	9213004

Air-side connector included at no extra cost

Weldable



Mount type	Mount diameter	CA	Reference	Part number
Single ended	–	–	BNC	9211000

Air-side connector included at no extra cost

 Part numbers printed in light blue indicate products that are suitable for -200 C cryogenic applications

Accessories

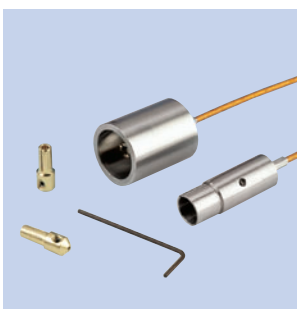

Description	Termination type	Cable length	Reference	Part number
Coaxial cable assembly	Grounded	500	KAP50-GS-500	1512507
Coaxial cable assembly	Grounded	1000	KAP50-GS-1000	1512508
Coaxial cable assembly	Floating	500	KAP50-FS-500	1512505
Coaxial cable assembly	Floating	1000	KAP50-FS-1000	1512506

All dimensions are nominal in millimetres unless specified



Section 6.2

BNC Coaxial

Grounded shield / double ended



Features

- Noise shield for instrumentation transmission
- Bayonet-style threadless connection
- Air-side connector included
- In-vacuum cables available
- Three standard vacuum mounting styles
- Custom feedthrough configurations available upon request

Specifications

Voltage¹ 500V DC maximum

Current 3A

Impedance rating Non constant

Material

Flanges 304ss

Shell 304ss

Pins 304ss

Insulation Alumina ceramic

Vacuum range UHV/HV 1×10^{-10} mbar / 1×10^{-8} mbar

Temperature range²

CF Mounted feedthrough -200°C to 450°C

ISO KF Mounted feedthrough -20°C to 150°C

Weldable feedthrough -200°C to 450°C

Air-side connector -65°C to 165°C

Dimensions Reference only, subject to change

¹ See intended operating parameters in introductory section

² Overall assembly ratings must be adjusted to that of the lowest rated component

Feedthroughs – electrical and optical

UHV and HV series

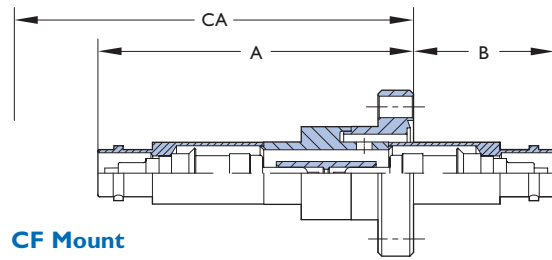

CF Mount

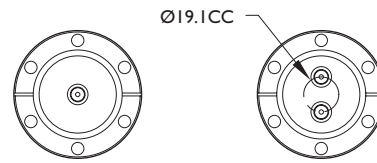
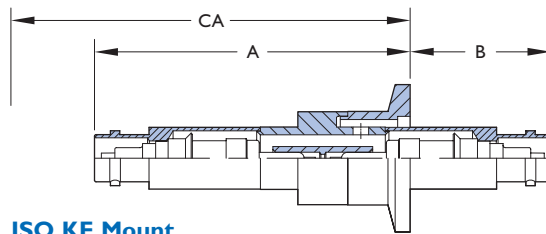

Figure 1

Figure 2

End views Vacuum-side



ISO KF Mount

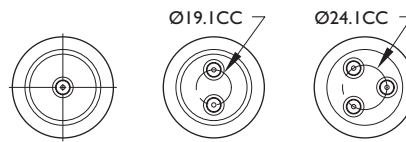
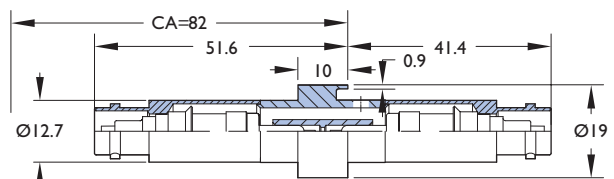

Figure 3

Figure 4

Figure 5

End views Vacuum-side



Weldable

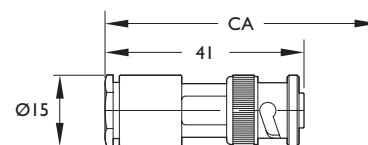

Air-side connector

All dimensions are nominal in millimetres unless specified

BNC Coaxial

Grounded shield / double ended



CF



No. of pins	Flange mount	End view	A	B	CA	Reference	Part number
1	DN16CF	1	64	29	84	BNCD-C16	9212005
1	DN40CF	1	54	39	74	BNCD-C40	9212006
2	DN40CF	2	54	39	74	BNCD-2-C40	9212007

Air-side connector included at no extra cost

ISO KF



No. of pins	Flange mount	End view	A	B	CA	Reference	Part number
1	DN16KF	3	64	29	84	BNCD-K16	9213005
1	DN40KF	3	52	41	72	BNCD-K40	9213006
2	DN50KF	4	52	41	72	BNCD-2-K50	9213007
3	DN50KF	5	52	41	72	BNCD-3-K50	9213008

Air-side connector included at no extra cost

Weldable



Mount type	Reference	Part number
Double ended	BNCD	9211001

Air-side connector included at no extra cost

 Part numbers printed in light blue indicate products that are suitable for -200 C cryogenic applications

BNC Coaxial

Floating shield / single and double ended



Features

- Noise shield for instrumentation transmission
- Bayonet-style threadless connection
- Air-side connector included
- In-vacuum cables available
- Three standard vacuum mounting styles
- Custom feedthrough configurations available upon request

Specifications

Voltage¹ 500V DC maximum

Current 3A

Impedance rating Non constant

Material

Flanges 304ss

Shell 304ss

Pins 304ss

Insulation Alumina ceramic

Vacuum range UHV/HV 1×10^{-10} mbar / 1×10^{-8} mbar

Temperature range²

CF Mounted feedthrough -200°C to 450°C

ISO KF Mounted feedthrough -20°C to 150°C

Weldable feedthrough -100°C to 450°C

Air-side connector -65°C to 165°C

Dimensions Reference only, subject to change

¹ See intended operating parameters in introductory section

² Overall assembly ratings must be adjusted to that of the lowest rated component

UHV and HV series

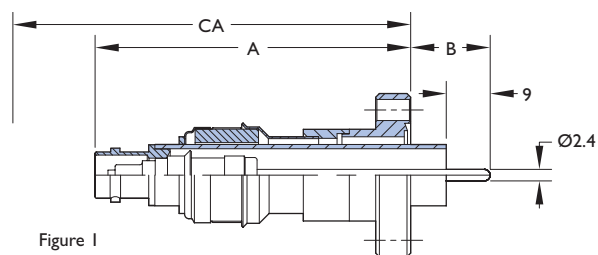

Figure 1

CF Mount Single ended

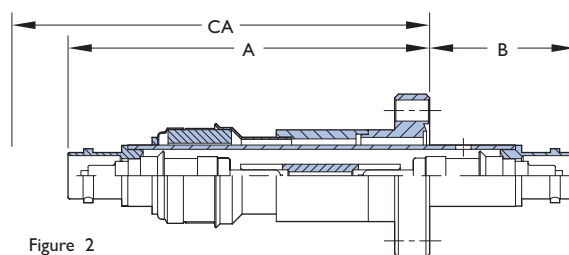

Figure 2

CF Mount Double ended

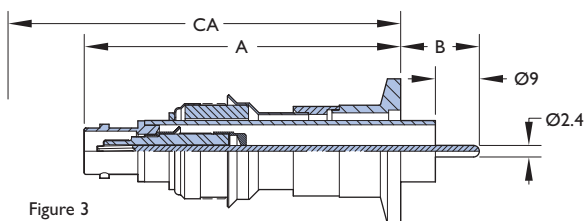

Figure 3

ISO KF Mount Single ended

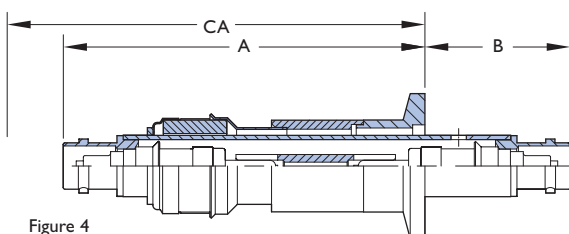

Figure 4

ISO KF Mount Double ended

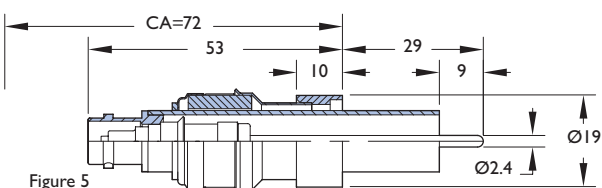

Figure 5

Weldable Single ended

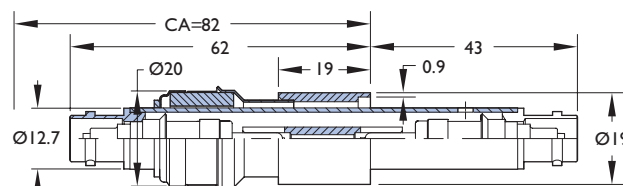

Figure 5

Weldable Double ended

All dimensions are nominal in millimetres unless specified

BNC Coaxial

Floating shield / single and double ended



CF

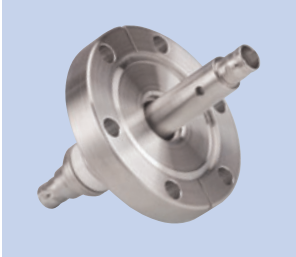

No. of pins	Flange mount	End view	A	B	CA	Reference	Part number
Single	DN16CF	I	32	17	85	FBNC-C16	9212013
Single	DN40CF	I	55	27	75	FBNC-C40	9212014
Double	DN16CF	I	75	30	95	FBNCD-C16	9212011
Double	DN40CF	I	64	40	84	FBNCD-C40	9212012

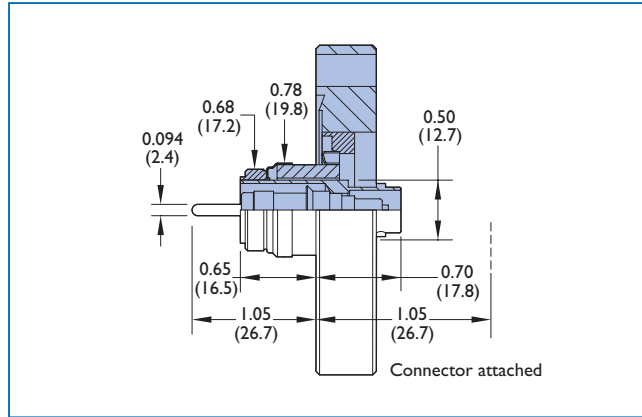

Air-side connector included at no extra cost.
Note The DN16CF feedthrough is not suitable for use with standard floating shield cable assembly use the grounded shield cable assembly. Instead (electrically the cable is the same).

ISO KF



No. of pins	Flange mount	End view	A	B	CA	Reference	Part number
Single	DN16KF	3	63	17	85	FBNC-K16	9213009
Single	DN40KF	3	54	19	23	FBNC-K40	9213010
Double	DN16KF	4	75	30	95	FBNCD-K16	9213011
Double	DN40KF	4	63	42	83	FBNCD-K40	9213012

Air-side connector included at no extra cost

Weldable



Mount type	Reference	Part number
Single ended	FBNC-W	9211006
Double ended	FBNCD	9211003

Air-side connector included at no extra cost

Accessories



Description	Quantity per pack	Reference	Part number
Power push-on	10	PPO-094	9924003
Power in-line	10	PIL-120	9924006

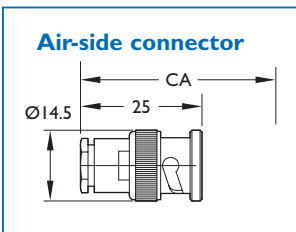

All dimensions are nominal in millimetres unless specified



Section 6.2

MHV Coaxial

Grounded shield / single ended



Features

- Medium power transmission with high-voltage requirements
- Bayonet-style threadless connection
- Air-side connector included
- In-vacuum cables available
- Three standard vacuum mounting styles
- Custom feedthrough configurations available upon request

Specifications

Voltage¹ 5,000V DC maximum

Current 3A

Impedance rating Non constant

Material

Flanges 304ss

Shell 304ss

Pins 304ss

Insulation Alumina ceramic

Vacuum range UHV/HV 1×10^{-10} mbar / 1×10^{-8} mbar

Temperature range²

CF Mounted feedthrough -200°C to 450°C

ISO KF Mounted feedthrough -20°C to 150°C

Weldable feedthrough -200°C to 450°C

Air-side connector -65°C to 165°C

Dimensions Reference only, subject to change

¹ See intended operating parameters in introductory section

² Overall assembly ratings must be adjusted to that of the lowest rated component

All dimensions are nominal in millimetres unless specified

UHV and HV series

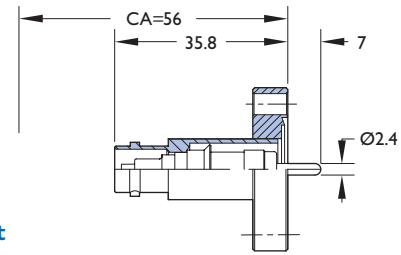

CF Mount

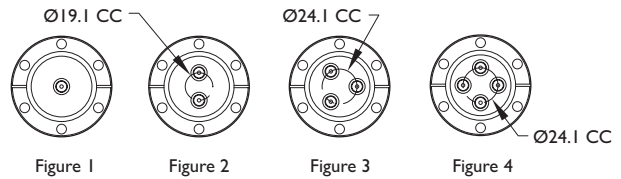

End views Vacuum-side

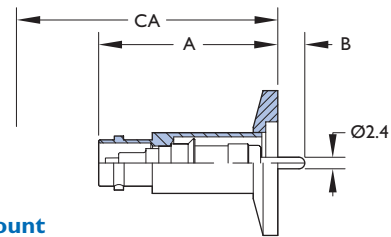

ISO KF Mount

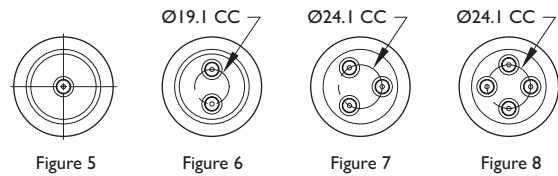

End views Vacuum-side

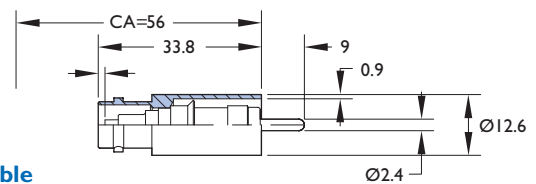

Weldable

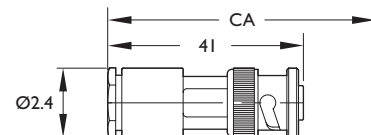

Air-side connector



CF



No. of pins	Flange mount	End view	Reference	Part number
1	DN16CF	1	MHV-C16	9222000
1	DN40CF	1	MHV-C40	9222001
2	DN40CF	2	MHV-2-C40	9222002
3	DN40CF	3	MHV-3-C40	9222003
4	DN40CF	4	MHV-4-C40	9222004

Air-side connector included at no extra cost

ISO KF



No. of pins	Flange mount	End view	A	B	CA	Reference	Part number
1	DN16KF	5	37.1	5.6	67	MHV-K16	9223000
1	DN40KF	5	34.5	8.1	64	MHV-K40	9223001
2	DN40KF	6	34.5	8.1	64	MHV-2-K40	9223002
3	DN50KF	7	34.5	8.1	64	MHV-3-K50	9223003
4	DN50KF	8	34.5	8.1	64	MHV-4-K50	9223004

Air-side connector included at no extra cost

Weldable



Mount type	Reference	Part number
Single ended	MHV	9221000

Air-side connector included at no extra cost

 Part numbers printed in light blue indicate products that are suitable for -200 C cryogenic applications

Accessories



Description	Quantity per pack	Reference	Part number
Power push-on	10	PPO-094	9924003
Power in-line	10	PIL-120	9924006

Description	Termination type	Cable length	Reference	Part number
Coaxial cable assembly	Grounded	500	KAP50-GS-500	1512507
Coaxial cable assembly	Grounded	1000	KAP50-GS-1000	1512508
Coaxial cable assembly	Floating	500	KAP50-FS-500	1512505
Coaxial cable assembly	Floating	1000	KAP50-FS-1000	1512506

All dimensions are nominal in millimetres unless specified



Section 6.2

MHV Coaxial

Grounded shield / double ended

MHV Coaxial



Features

- Medium power transmission with high-voltage requirements
- Bayonet-style threadless connection
- Air-side connector included
- In-vacuum cables available
- Three standard vacuum mounting styles
- Custom feedthrough configurations available upon request

Specifications

Voltage¹ 5,000V DC maximum

Current 3A

Impedance rating Non constant

Material

Flanges 304ss

Shell 304ss

Pins 304ss

Insulation Alumina ceramic

Vacuum range UHV/HV 1×10^{-10} mbar / 1×10^{-8} mbar

Temperature range

²

CF Mounted feedthrough -200°C to 450°C

ISO KF Mounted feedthrough -20°C to 150°C

Weldable feedthrough -200°C to 450°C

Air-side connector -65°C to 165°C

Dimensions Reference only, subject to change

¹ See intended operating parameters in introductory section

² Overall assembly ratings must be adjusted to that of the lowest rated component

All dimensions are nominal in millimetres unless specified

Feedthroughs – electrical and optical

UHV and HV series

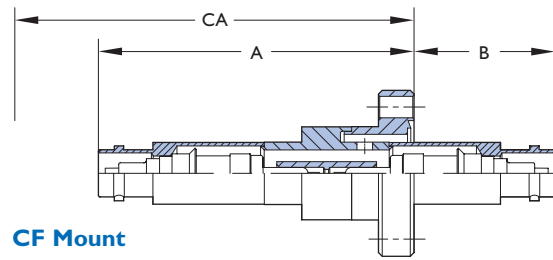

CF Mount

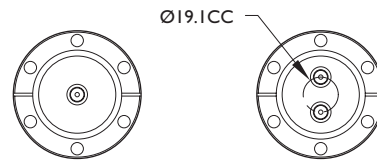
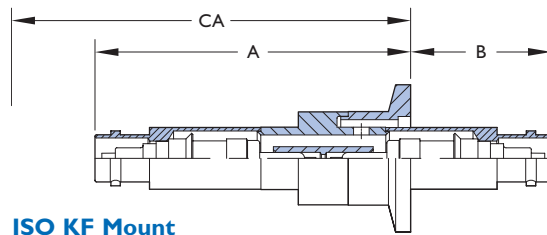

Figure 1

Figure 2

End views Vacuum-side



ISO KF Mount

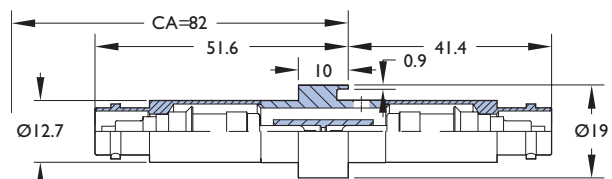

Figure 3

Figure 4

Figure 5

End views Vacuum-side



Weldable

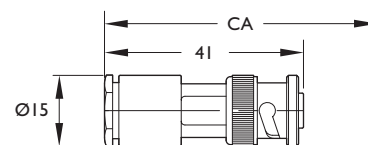

Air-side connector



CF



No. of pins	Flange mount	End view	A	B	CA	Reference	Part number
1	DN16CF	1	64	29	94	MHVD-C16	9222005
1	DN40CF	1	54	39	83	MHVD-C40	9222006
2	DN40CF	2	54	39	83	MHVD-2-C40	9222007

Air-side connector included at no extra cost

ISO KF



No. of pins	Flange mount	End view	A	B	CA	Reference	Part number
1	DN16KF	3	64	29	94	MHVD-K16	9223005
1	DN40KF	3	52	41	82	MHVD-K40	9223006
2	DN50KF	4	52	41	82	MHVD-2-K50	9223007
3	DN50KF	5	52	41	82	MHVD-3-K50	9223008

Air-side connector included at no extra cost

Weldable



Mount type	Reference	Part number
Double ended	MHVD	9221001

Air-side connector included at no extra cost

 Part numbers printed in light blue indicate products that are suitable for -200 C cryogenic applications



Features

- Medium power transmission with high-voltage requirements
- Bayonet-style threadless connection
- Air-side connector included
- In-vacuum cables available
- Three standard vacuum mounting styles
- Custom feedthrough configurations available upon request

Specifications

Voltage¹ 5,000V DC maximum

Current 3A

Impedance rating Non constant

Material

Flanges 304ss

Shell 304ss

Pins 304ss

Insulation Alumina ceramic

Vacuum range UHV/HV 1×10^{-10} mbar / 1×10^{-8} mbar

Temperature range²

CF Mounted feedthrough -100°C to 450°C

ISO KF Mounted feedthrough -20°C to 150°C

Weldable feedthrough -100°C to 450°C

Air-side connector -65°C to 165°C

Dimensions Reference only, subject to change

¹ See intended operating parameters in introductory section

² Overall assembly ratings must be adjusted to that of the lowest rated component

All dimensions are nominal in millimetres unless specified

UHV and HV series

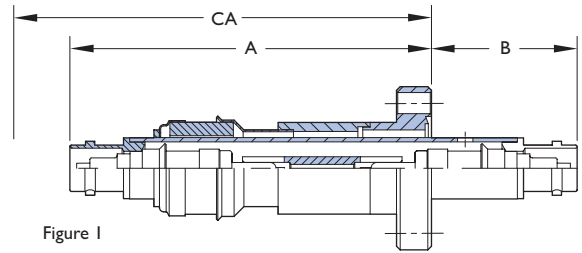

Figure 1

CF Mount Double ended

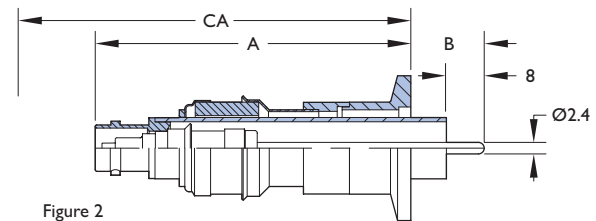

Figure 2

ISO KF Mount Single ended

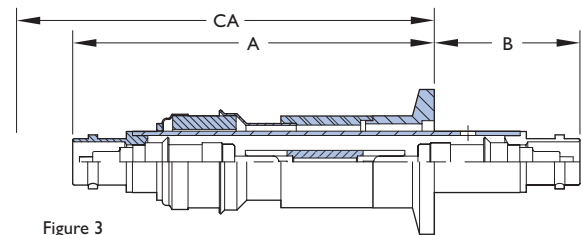

Figure 3

ISO KF Mount Double ended

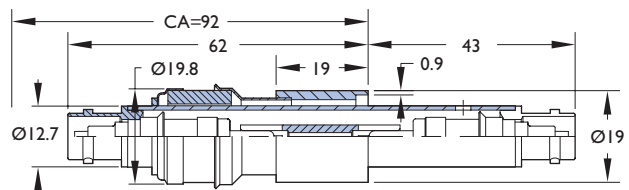

Figure 4

Weldable Double ended



Floating shield / single and double ended

CF



End type	Flange mount	Figure	A	B	C	CA	Reference	Part number
Single	DN16CF	1	66	16	7	95	FMHV-C16	9922013
Single	DN40CF	1	55	26	13	85	FMHV-C40	9922014
Double	DN16CF	1	75	30	7	105	FMHVD-C16	9222011
Double	DN40CF	1	64	41	13	94	FMHVD-C40	9222012

Air-side connector included at no extra cost

ISO KF



End type	Flange mount	Figure	A	B	CA	Reference	Part number
Single	DN16KF	2	66	16	95	FMHV-K16	9223009
Single	DN40KF	2	54	19	83	FMHV-K40	9223010
Double	DN16KF	3	75	30	105	FMHVD-K16	9223011
Double	DN40KF	3	63	42	93	FMHVD-K40	9223012

Air-side connector included at no extra cost

Weldable



Mount type	Figure	CA	Reference	Part number
Single ended	5	82	FMHV	9221006
Double ended	4	92	FMHVD	9221003

Air-side connector included at no extra cost

 Part numbers printed in light blue indicate products that are suitable for -200 C cryogenic applications

Accessories



Description	Quantity per pack	Reference	Part number
Power push-on	10	PPO-094	9924003
Power in-line	10	PIL-I20	9924006

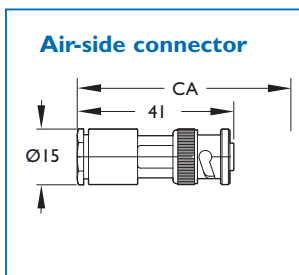

All dimensions are nominal in millimetres unless specified



Features

- Recessed contact design for safe high-voltage connection
- Bayonet-style threadless connection
- Air-side connector included
- Three standard vacuum mounting styles
- Custom feedthrough configurations available upon request

Specifications

Voltage¹	5,000V DC maximum
Current	5A
Impedance rating	Non constant
Material	
Flanges	304ss
Shell	304ss
Pins	Nickel
Insulation	Alumina ceramic
Vacuum range UHV/HV	1×10^{-10} mbar / 1×10^{-8} mbar
Temperature range²	
CF Mounted feedthrough	-200°C to 450°C
ISO KF Mounted feedthrough	-20°C to 150°C
Weldable feedthrough	-200°C to 450°C
Air-side connector	-65°C to 165°C
Dimensions	Reference only, subject to change

¹ See intended operating parameters in introductory section

² Overall assembly ratings must be adjusted to that of the lowest rated component

UHV and HV series

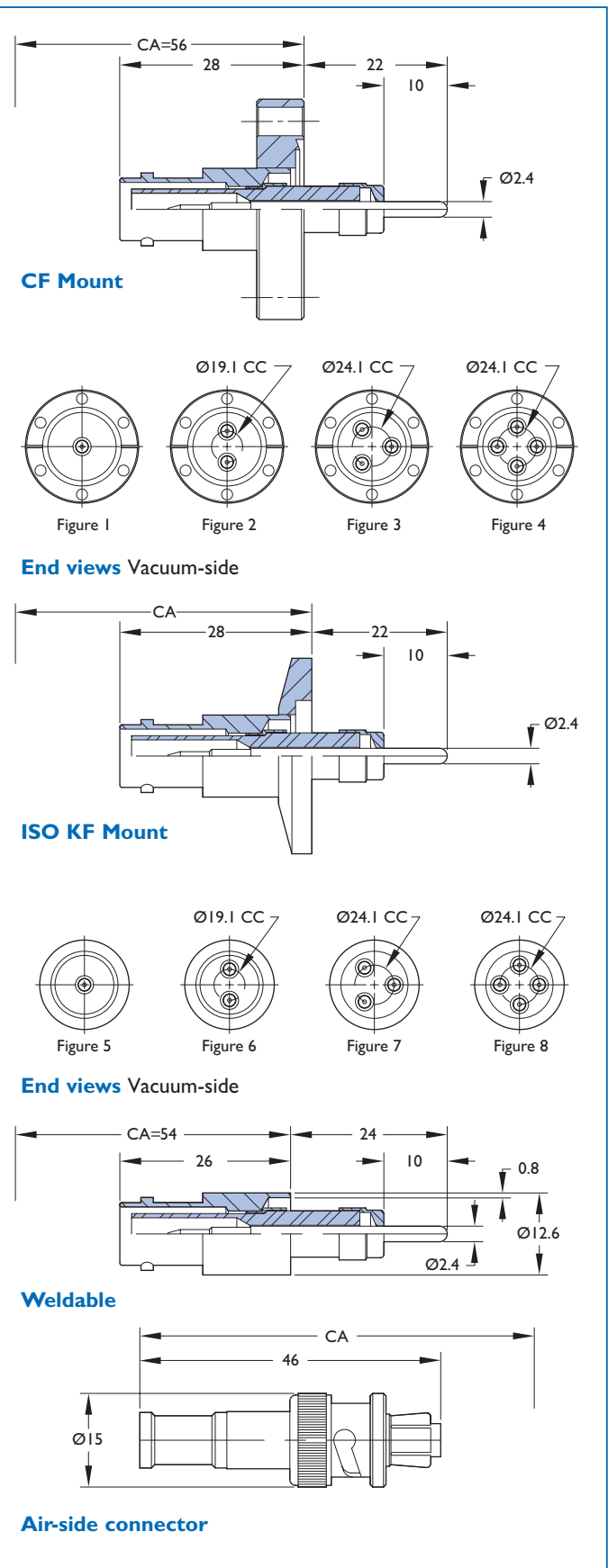

All dimensions are nominal in millimetres unless specified



CF



No. of pins	Flange mount	End view	Reference	Part number
1	DN16CF	1	SHVE-C16	9232005
1	DN40CF	1	SHVE-C40	9232006
2	DN40CF	2	SHVE-2-C40	9232007
3	DN40CF	3	SHVE-3-C40	9232008
4	DN40CF	4	SHVE-4-C40	9232009

Air-side connector included at no extra cost

Part numbers printed in light blue indicate products that are suitable for -200 C cryogenic applications

ISO KF



No. of pins	Flange mount	End view	A	B	CA	Reference	Part number
1	DN16KF	5	30	20.8	58	SHVE-K16	9233005
1	DN40KF	5	30	23.4	55	SHVE-1-K40	9233006
2	DN40KF	6	30	23.4	55	SHVE-2-K40	9233007
3	DN50KF	7	30	23.4	55	SHVE-3-K50	9233008
4	DN50KF	8	30	23.4	55	SHVE-4-K50	9233009

Air-side connector included at no extra cost

Weldable



Mount type	Reference	Part number
Single ended	SHVE	9231001

Air-side connector included at no extra cost

Part numbers printed in light blue indicate products that are suitable for -200 C cryogenic applications

Accessories

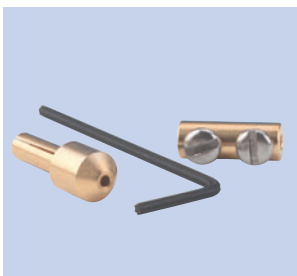

Accessory type	Material	Quantity per pack	Reference	Part number
Power push-on	BeCU	10	PPO-094	9924003
Power in-line	BeCU	10	PIL-120	9924006

All dimensions are nominal in millimetres unless specified



Section 6.2

SHV-5 Coaxial

Recessed

Feedthroughs – electrical and optical



Features

- Recessed contact design for safe high-voltage connection
- Bayonet-style threadless connection
- Air-side connector included
- Three standard vacuum mounting styles
- Custom feedthrough configurations available upon request

Specifications

Voltage¹ 5,000V DC maximum

Current 5A

Impedance rating Non constant

Material

Flanges 304ss

Shell 304ss

Pins Nickel

Insulation Alumina ceramic

Vacuum range UHV/HV 1×10^{-10} mbar / 1×10^{-8} mbar

Temperature range²

CF Mounted feedthrough -200°C to 450°C

ISO KF Mounted feedthrough -20°C to 150°C

Weldable feedthrough -200°C to 450°C

Air-side connector -65°C to 165°C

Dimensions Reference only, subject to change

¹ See intended operating parameters in introductory section

² Overall assembly ratings must be adjusted to that of the lowest rated component

UHV and HV series

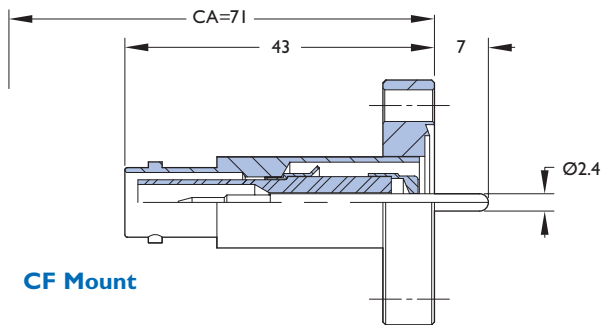

CF Mount

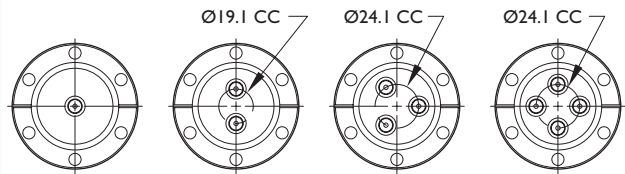

Figure 1

Figure 2

Figure 3

Figure 4

End views Vacuum-side

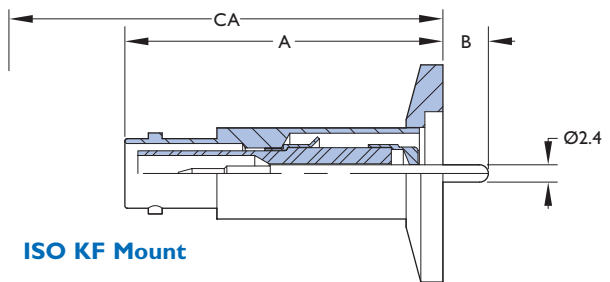

ISO KF Mount

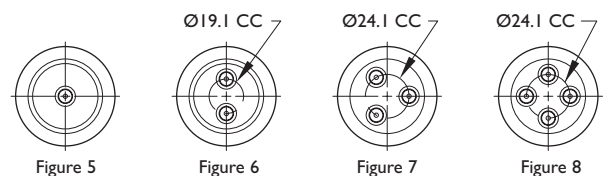

Figure 5

Figure 6

Figure 7

Figure 8

End views Vacuum-side

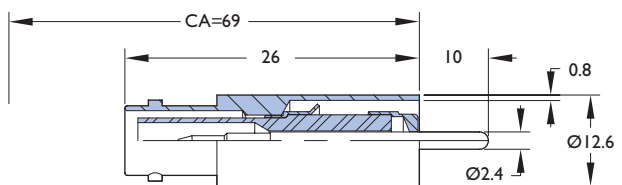

Weldable

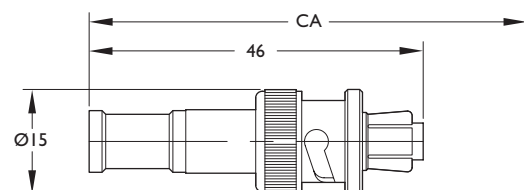

Air-side connector

All dimensions are nominal in millimetres unless specified



CF



No. of pins	Flange mount	End view	Reference	Part number
1	DN16CF	1	SHV-C16	9232000
1	DN40CF	1	SHV-C40	9232001
2	DN40CF	2	SHV-2-C40	9232002
3	DN40CF	3	SHV-3-C40	9232003
4	DN40CF	4	SHV-4-C40	9232004

Air-side connector included at no extra cost

Part numbers printed in light blue indicate products that are suitable for -200 C cryogenic applications

ISO KF



No. of pins	Flange mount	End view	A	B	CA	Reference	Part number
1	DN16KF	5	44	6	72	SHV-K16	9233000
1	DN40KF	5	41	9	69	SHV-K40	9233001
2	DN40KF	6	41	9	69	SHV-2-K40	9233002
3	DN50KF	7	41	9	69	SHV-3-K50	9233003
4	DN50KF	8	41	9	69	SHV-4-K50	9233004

Air-side connector included at no extra cost

Weldable



Mount type	Reference	Part number
Single ended	SHV	9231000

Air-side connector included at no extra cost

Part numbers printed in light blue indicate products that are suitable for -200 C cryogenic applications

Accessories



Accessory type	Material	Quantity per pack	Reference	Part number
Power push-on	BeCU	10	PPO-094	9924003
Power in-line	BeCU	10	PIL-I20	9924006

All dimensions are nominal in millimetres unless specified



Section 6.2

SHV-10 Coaxial

Exposed

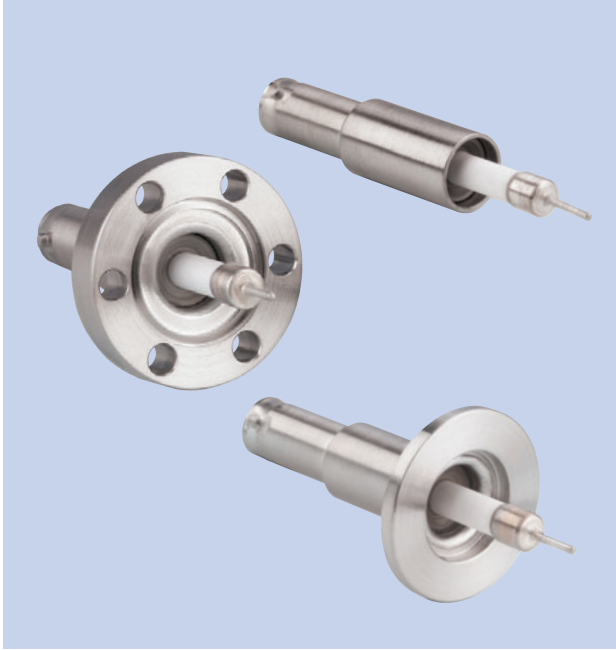

Features

- Recessed contact design for safe high-voltage connection
- Bayonet-style threadless connection
- Air-side connector included
- Three standard vacuum mounting styles
- Custom feedthrough configurations available upon request

Specifications

Voltage¹ 10,000V DC maximum

Current 5A

Impedance rating Non constant

Material

Flanges 304ss

Shell 304ss

Pins Nickel

Insulation Alumina ceramic

Vacuum range UHV/HV 1×10^{-10} mbar / 1×10^{-8} mbar

Temperature range²

CF Mounted feedthrough -100°C to 450°C

ISO KF Mounted feedthrough -20°C to 150°C

Weldable feedthrough -100°C to 450°C

Air-side connector -65°C to 165°C

Dimensions Reference only, subject to change

¹ See intended operating parameters in introductory section

² Overall assembly ratings must be adjusted to that of the lowest rated component

UHV and HV series

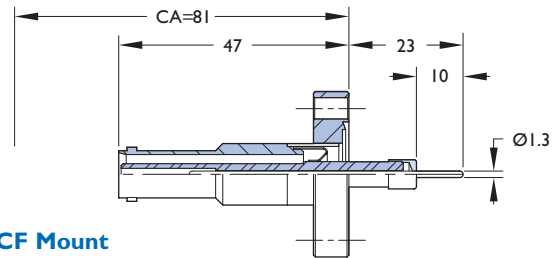

CF Mount

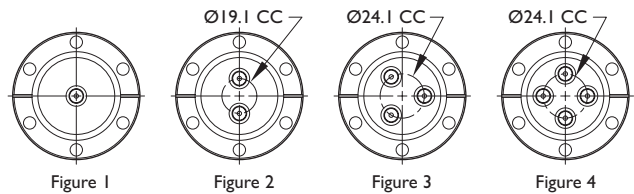

End views Air-side

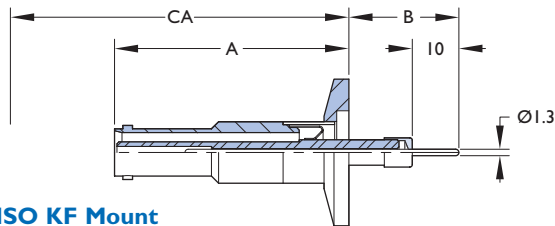

ISO KF Mount

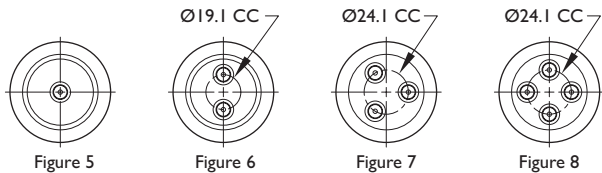

End views Air-side

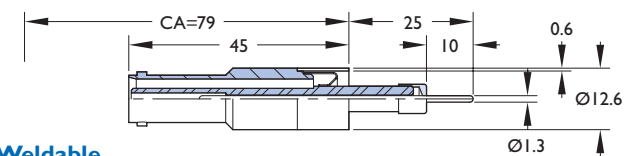

Weldable

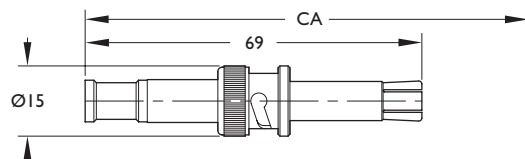

Air-side connector

All dimensions are nominal in millimetres unless specified



CF



No. of pins	Flange mount	End view	Reference	Part number
1	DN16CF	1	SHVE10-1-C16	9232017
1	DN40CF	1	SHVE10-1-C40	9232018
2	DN40CF	2	SHVE10-2-C40	9232019
3	DN40CF	3	SHVE10-3-C40	9232020
4	DN40CF	4	SHVE10-4-C40	9232021

Air-side connector included at no extra cost

 Part numbers printed in light blue indicate products that are suitable for -200 C cryogenic applications

ISO KF



No. of pins	Flange mount	End view	A	B	CA	Reference	Part number
1	DN16KF	5	48	23	82	SHVE10-1-K16	9233017
1	DN40KF	5	46	25	79	SHVE10-1-K40	9233018
2	DN40KF	6	46	25	79	SHVE10-2-K40	9233019
3	DN50KF	7	46	25	79	SHVE10-3-K50	9233020
4	DN50KF	8	46	25	79	SHVE10-4-K50	9233021

Air-side connector included at no extra cost

Weldable



Mount type	Reference	Part number
Single ended	SHVE10-1-W	9231005

Air-side connector included at no extra cost

 Part numbers printed in light blue indicate products that are suitable for -200 C cryogenic applications

Accessories



Accessory type	Material	Quantity per pack	Reference	Part number
Power push-on	BeCU	10	PPO-050	9924001
Power in-line	BeCU	10	PIL-059	9924004

All dimensions are nominal in millimetres unless specified



Section 6.2

SHV-10 Coaxial

Recessed

Feedthroughs – electrical and optical



Features

- Recessed contact design for safe high-voltage connection
- Bayonet-style threadless connection
- Air-side connector included
- Three standard vacuum mounting styles
- Custom feedthrough configurations available upon request

Specifications

Voltage¹ 10,000V DC maximum

Current 5A

Impedance rating Non constant

Material

Flanges 304ss

Shell 304ss

Pins Nickel

Insulation Alumina ceramic

Vacuum range UHV/HV 1×10^{-10} mbar/ 1×10^{-8} mbar

Temperature range²

CF Mounted feedthrough -100°C to 450°C

ISO KF Mounted feedthrough -20°C to 150°C

Weldable feedthrough -100°C to 450°C

Air-side connector -65°C to 165°C

Dimensions Reference only, subject to change

¹ See intended operating parameters in introductory section

² Overall assembly ratings must be adjusted to that of the lowest rated component

UHV and HV series

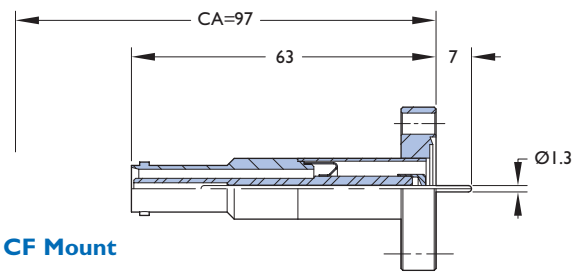

CF Mount

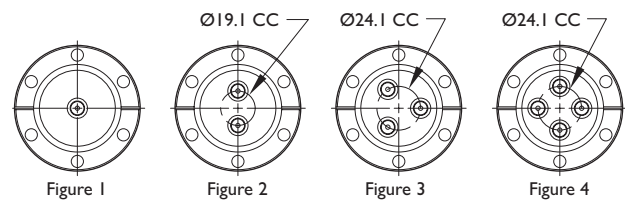

End views Air-side

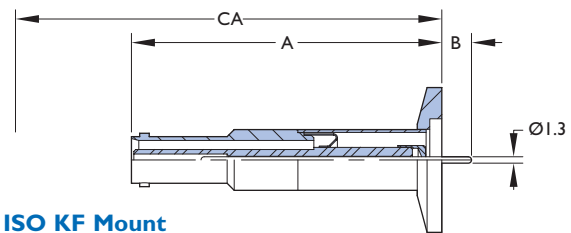

ISO KF Mount

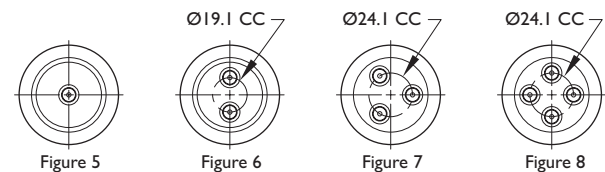

End views Air-side

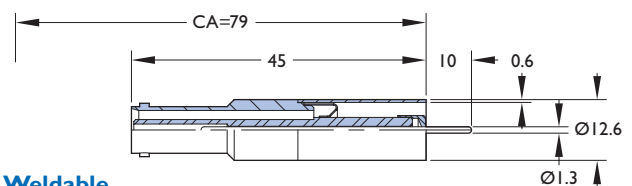

Weldable

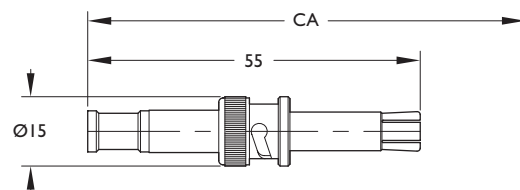

Air-side connector

All dimensions are nominal in millimetres unless specified



CF



No. of pins	Flange mount	End view	Reference	Part number
1	DN16CF	1	SHVR10-1-C16	9232012
1	DN40CF	1	SHVR10-1-C40	9232013
2	DN40CF	2	SHVR10-2-C40	9232014
3	DN40CF	3	SHVR10-3-C40	9232015
4	DN40CF	4	SHVR10-4-C40	9232016

Air-side connector included at no extra cost

ISO KF



No. of pins	Flange mount	End view	A	B	CA	Reference	Part number
1	DN16KF	5	64	6	98	SHVR10-1-K16	9233012
1	DN40KF	5	62	9	96	SHVR10-1-K40	9233013
2	DN40KF	6	62	9	96	SHVR10-2-K40	9233014
3	DN50KF	7	62	9	96	SHVR10-3-K50	9233015
4	DN50KF	8	62	9	96	SHVR10-4-K50	9233016

Air-side connector included at no extra cost

Weldable



Mount type	Reference	Part number
Single ended	SHVR10-1-W	9231004

Air-side connector included at no extra cost

Accessories



Accessory type	Material	Quantity per pack	Reference	Part number
Power push-on	BeCU	10	PPO-050	9924001
Power in-line	BeCU	10	PIL-059	9924004

All dimensions are nominal in millimetres unless specified



Features

- Recessed contact design for safe high-voltage connection
- Bayonet-style threadless connection
- Air-side connector included
- Three standard vacuum mounting styles
- Custom feedthrough configurations available upon request

Specifications

Voltage¹ 20,000V DC maximum

Current 15A

Impedance rating Non constant

Material

Flanges 304ss

Shell 304ss

Pins Nickel

Insulation Alumina ceramic

Vacuum range UHV/HV 1×10^{-10} mbar / 1×10^{-8} mbar

Temperature range²

CF Mounted feedthrough -200°C to 450°C

ISO KF Mounted feedthrough -20°C to 150°C

Weldable feedthrough -200°C to 450°C

Air-side connector -65°C to 165°C

Dimensions Reference only, subject to change

¹ See intended operating parameters in introductory section

² Overall assembly ratings must be adjusted to that of the lowest rated component

UHV and HV series

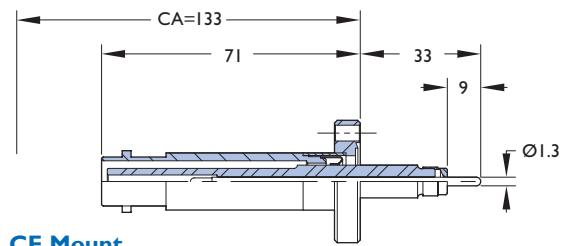

CF Mount



Figure 1

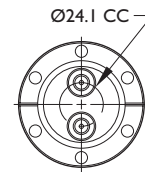
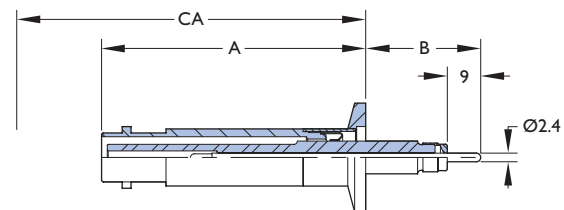

Figure 2

End views Vacuum-side



ISO KF Mount



Figure 1

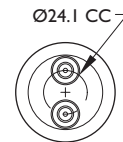
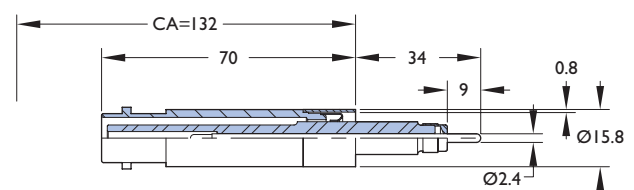
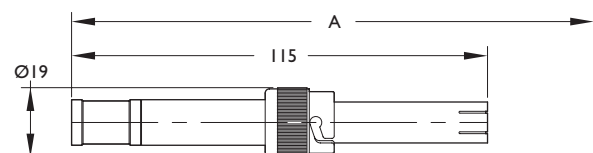

Figure 2

End views Vacuum-side



Weldable



Air-side connector



CF



No. of pins	Flange mount	End view	Reference	Part number
1	DN16CF	1	SHVE20-1-C16	9272006
1	DN40CF	1	SHVE20-1-C40	9272007
2	DN40CF	2	SHVE20-2-C40	9272008

Air-side connector included at no extra cost

 Part numbers printed in light blue indicate products that are suitable for -200 C cryogenic applications

ISO KF



No. of pins	Flange mount	End view	A	B	CA	Reference	Part number
1	DN16KF	3	73	32	134	SHVE20-1-K16	9273006
1	DN40KF	3	70	35	132	SHVE20-1-K40	9273007
2	DN50KF	4	70	35	132	SHVE20-2-K50	9273008

Air-side connector included at no extra cost

Weldable



Mount type	Reference	Part number
Single ended	SHVE20-1-W	9271002

Air-side connector included at no extra cost

 Part numbers printed in light blue indicate products that are suitable for -200 C cryogenic applications

Accessories

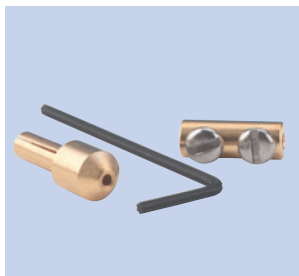

Accessory type	Material	Quantity per pack	Reference	Part number
Power push-on	BeCU	10	PPO-094	9924003
Power in-line	BeCU	10	PIL-120	9924006

All dimensions are nominal in millimetres unless specified

SHV-20 Coaxial

Recessed



Features

- Recessed contact design for safe high-voltage connection
- Bayonet-style threadless connection
- Air-side connector included
- Three standard vacuum mounting styles
- Custom feedthrough configurations available upon request

Specifications

Voltage¹ 20,000V DC maximum

Current 15A

Impedance rating Non constant

Material

Flanges 304ss

Shell 304ss

Pins Nickel

Insulation Alumina ceramic

Vacuum range UHV/HV 1×10^{-10} mbar / 1×10^{-8} mbar

Temperature range²

CF Mounted feedthrough -200°C to 450°C

ISO KF Mounted feedthrough -20°C to 150°C

Weldable feedthrough -200°C to 450°C

Air-side connector -65°C to 165°C

Dimensions Reference only, subject to change

¹ See intended operating parameters in introductory section

² Overall assembly ratings must be adjusted to that of the lowest rated component

UHV and HV series

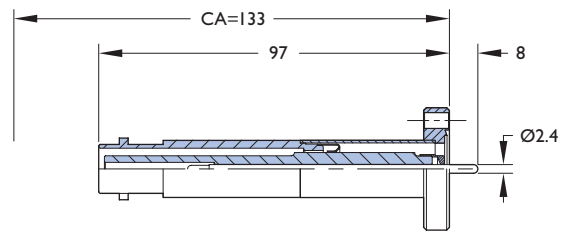

CF Mount

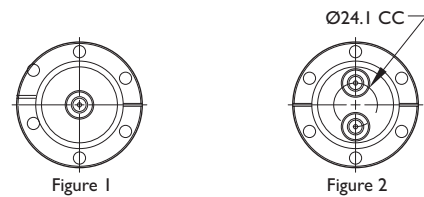

End views Vacuum-side

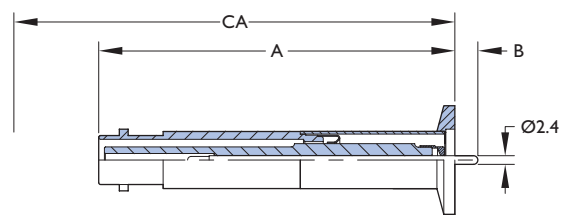

ISO KF Mount



End views Vacuum-side

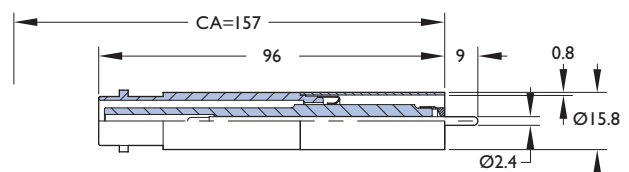

Weldable

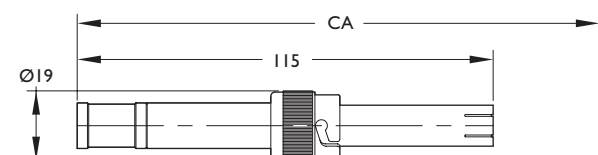

Air-side connector

All dimensions are nominal in millimetres unless specified



CF



No. of pins	Flange mount	End view	Reference	Part number
1	DN16CF	1	SHVR20-1-C16	9272009
1	DN40CF	1	SHVR20-1-C40	9272010
2	DN40CF	2	SHVR20-2-C40	9272011

Air-side connector included at no extra cost

 Part numbers printed in light blue indicate products that are suitable for -200 C cryogenic applications

ISO KF



No. of pins	Flange mount	End view	A	B	CA	Reference	Part number
1	DN16KF	3	98	7	160	SHVR20-1-K16	9273009
1	DN40KF	3	96	9	157	SHVR20-1-K40	9273010
2	DN50KF	4	96	9	157	SHVR20-2-K50	9273011

Air-side connector included at no extra cost

Weldable



Mount type	Reference	Part number
Single ended	SHVR20-1-W	9271003

Air-side connector included at no extra cost

 Part numbers printed in light blue indicate products that are suitable for -200 C cryogenic applications

Accessories

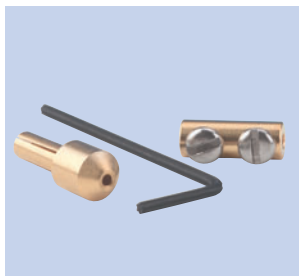

Accessory type	Material	Quantity per pack	Reference	Part number
Power push-on	BeCU	10	PPO-094	9924003
Power in-line	BeCU	10	PIL-120	9924006

All dimensions are nominal in millimetres unless specified



Section 6.2

SHV-B Coaxial

7,500V / 3A

SHV-B Coaxial



Features

- Recessed contact design for safe high-voltage connection
- Air-side connector included
- Three standard vacuum mounting styles
- Custom feedthrough configurations available upon request

Specifications

Voltage¹ 7,500V DC maximum

Current 3A

Impedance rating Non constant

Material

Flanges 304ss

Shell 304ss

Pins 304ss

Insulation Alumina ceramic

Vacuum range UHV/HV 1×10^{-10} mbar / 1×10^{-8} mbar

Temperature range²

CF Mounted feedthrough -200°C to 450°C

ISO KF Mounted feedthrough -20°C to 150°C

Weldable feedthrough -200°C to 450°C

Air-side connector -200°C to 350°C

Dimensions Reference only, subject to change

¹ See intended operating parameters in introductory section

² Overall assembly ratings must be adjusted to that of the lowest rated component

Feedthroughs – electrical and optical

UHV and HV series

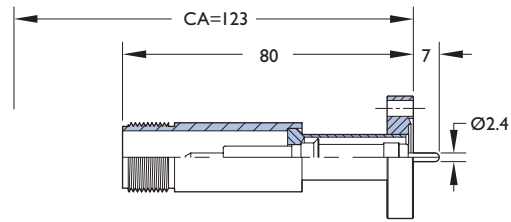

CF Mount

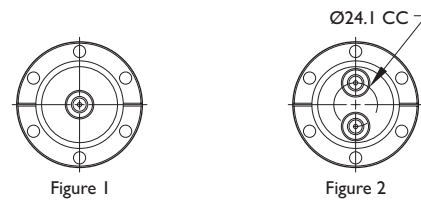

End views Air-side

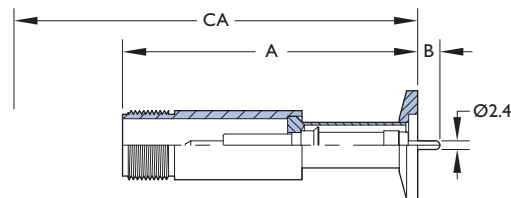

ISO KF Mount



End views Air-side

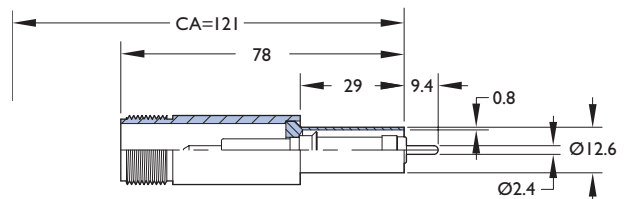

Weldable

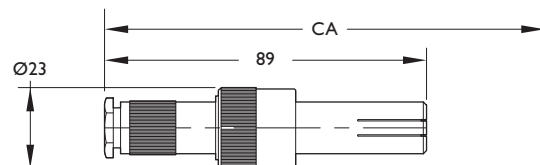

Air-side connector

All dimensions are nominal in millimetres unless specified



CF



No. of pins	Flange mount	End view	Reference	Part number
1	DN16CF	1	BSHV-C16	9262000
1	DN40CF	1	BSHV-C40	9262001
2	DN40CF	2	BSHV-2-C40	9262002

Air-side connector included at no extra cost

 Part numbers printed in light blue indicate products that are suitable for -200 C cryogenic applications

ISO KF



No. of pins	Flange mount	End view	A	B	CA	Reference	Part number
1	DN16KF	3	82	6	125	BSHV-K16	9263000
1	DN40KF	3	79	9	123	BSHV-K40	9263001
2	DN50KF	4	79	9	123	BSHV-2-K40	9263002

Air-side connector included at no extra cost

Weldable

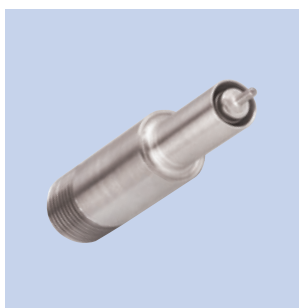

Mount type	Reference	Part number
Single ended	BSHV	9261000

Air-side connector included at no extra cost

 Part numbers printed in light blue indicate products that are suitable for -200 C cryogenic applications

Accessories

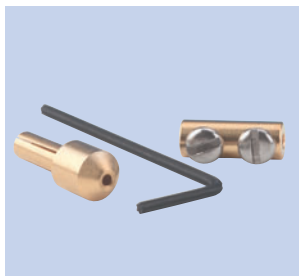

Accessory type	Material	Quantity per pack	Reference	Part number
Power, push-on	BeCU	10	PPO-094	9924003
Power in-line	BeCU	10	PIL-120	9924006

All dimensions are nominal in millimetres unless specified

Type-N Coaxial

Single and double ended



Features

- High-frequency signal transmission to 1GHz
- Air-side connector included
- Three standard vacuum mounting styles
- Custom feedthrough configurations available upon request

Specifications

Voltage¹ 500V DC maximum

Current 3A

Impedance rating Non constant

Material

Flanges 304ss

Shell 304ss

Pins Nickel

Insulation Alumina ceramic

Vacuum range UHV/HV 1×10^{-10} mbar / 1×10^{-8} mbar

Temperature range²

CF Mounted feedthrough -200°C to 450°C

ISO KF Mounted feedthrough -20°C to 150°C

Weldable feedthrough -200°C to 450°C

Air-side connector -65°C to 165°C

Dimensions Reference only, subject to change

¹ See intended operating parameters in introductory section

² Overall assembly ratings must be adjusted to that of the lowest rated component

UHV and HV series

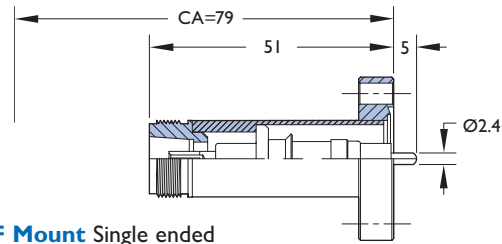

CF Mount Single ended

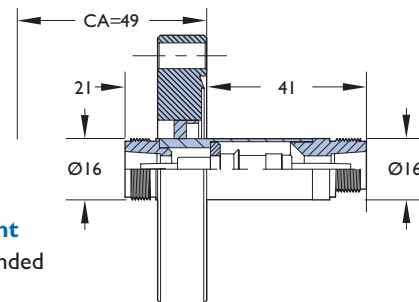

CF Mount Double ended

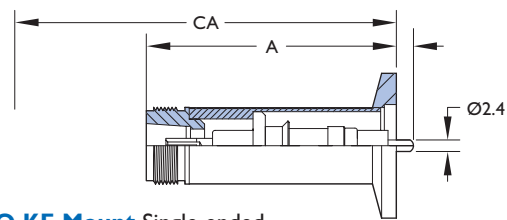

ISO KF Mount Single ended

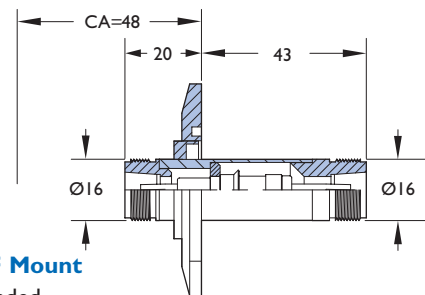

ISO KF Mount Single ended

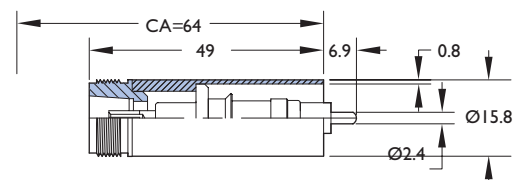

Weldable Single ended

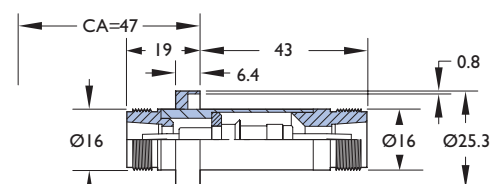

Weldable Double ended

All dimensions are nominal in millimetres unless specified

Type-N Coaxial

Single and double ended



CF



No. of pins	End type	Flange mount	Bolt circle	Reference	Part number
1	Single ended	DN16CF	–	N-C16	9242000
1	Single ended	DN40CF	–	N-C40	9242001
2	Single ended	DN40CF	24.1	N-2-C40	9242002
1	Double ended	DN40CF	–	ND-C40	9242003

Air-side connector included at no extra cost

 Part numbers printed in light blue indicate products that are suitable for -200 C cryogenic applications

ISO KF



No. of pins	End type	Flange mount	Bolt circle	A	B	CA	Reference	Part number
1	Single ended	DN16KF	–	52	3.6	80	N-K16	9243000
1	Single ended	DN40KF	–	49	6.1	77	N-K40	9243001
2	Single ended	DN50KF	24.1	97	6.1	77	N-2-K50	9243002
1	Double ended	DN40KF	–	–	–	–	ND-K40	9243003

Air-side connector included at no extra cost

Weldable



Mount type	Reference	Part number
Single ended	N	9241000
Double ended	ND	9241001

Air-side connector included at no extra cost

 Part numbers printed in light blue indicate products that are suitable for -200 C cryogenic applications

Accessories

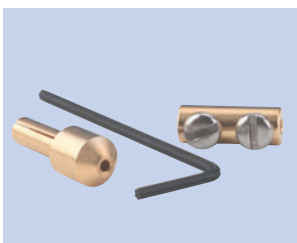

Accessory type	Material	Quantity per pack	Reference	Part number
Power push-on	BeCU	10	PPO-094	9924003
Power in-line	BeCU	10	PIL-I20	9924006

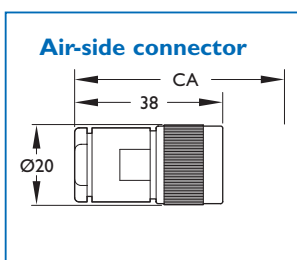

All dimensions are nominal in millimetres unless specified



Features

- High-frequency signal transmission to 1GHz
- Air-side connector included
- Three standard vacuum mounting styles
- Custom feedthrough configurations available upon request

Specifications

Voltage¹ 700V DC maximum

Current 1A

Impedance rating Non constant

Material

Flanges 304ss

Shell 304ss

Pins 304ss

Insulation Alumina ceramic

Vacuum range UHV/HV 1×10^{-10} mbar / 1×10^{-8} mbar

Temperature range²

CF Mounted feedthrough -200°C to 450°C

ISO KF Mounted feedthrough -20°C to 150°C

Weldable feedthrough -200°C to 450°C

Air-side connector -65°C to 165°C

Dimensions Reference only, subject to change

¹ See intended operating parameters in introductory section

² Overall assembly ratings must be adjusted to that of the lowest rated component

UHV and HV series

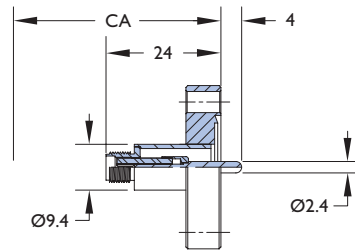

CF Mount Single ended

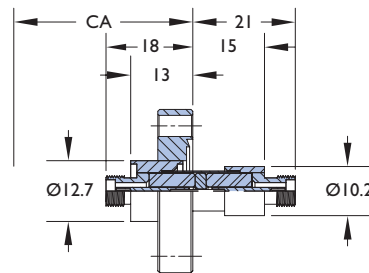

CF Mount Double ended

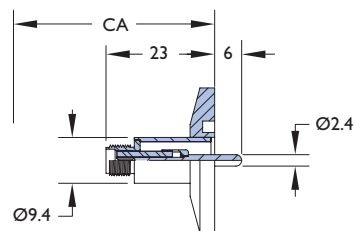

ISO KF Mount Single ended

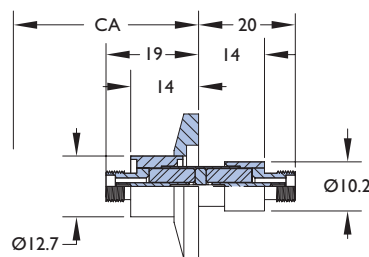

ISO KF Mount Double ended

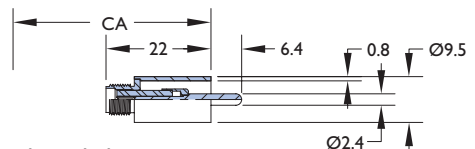

Weldable Single ended

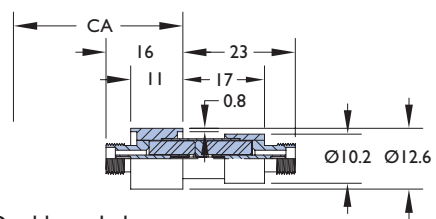

Weldable Double ended

All dimensions are nominal in millimetres unless specified



CF



End type	Flange mount	CA	Reference	Part number
Single ended	DN16CF	43	SMA-C16	9252000
Double ended	DN16CF	37	SMAD-C16	9252001

Air-side connector included at no extra cost

 Part numbers printed in light blue indicate products that are suitable for -200 C cryogenic applications

ISO KF

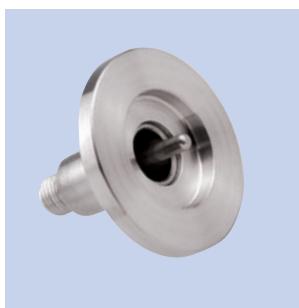

End type	Flange mount	CA	Reference	Part number
Single ended	DN16KF	43	SMA-K16	9253000
Double ended	DN16KF	37	SMAD-K16	9253001

Air-side connector included at no extra cost

Weldable



Mount type	CA	Reference	Part number
Single ended	41	SMA	9251000
Double ended	35	SMAD	9251001

Air-side connector included at no extra cost

 Part numbers printed in light blue indicate products that are suitable for -200 C cryogenic applications

Accessories

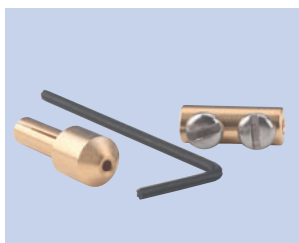

Accessory type	Material	Quantity per pack	Reference	Part number
Power push-on	BeCU	10	PPO-094	9924003
Power in-line	BeCU	10	PIL-I20	9924006

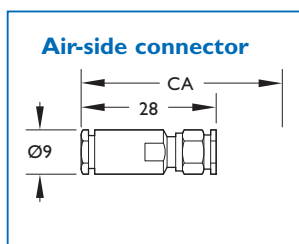

All dimensions are nominal in millimetres unless specified. Weights given are approximate.

SMA Coaxial

High frequency

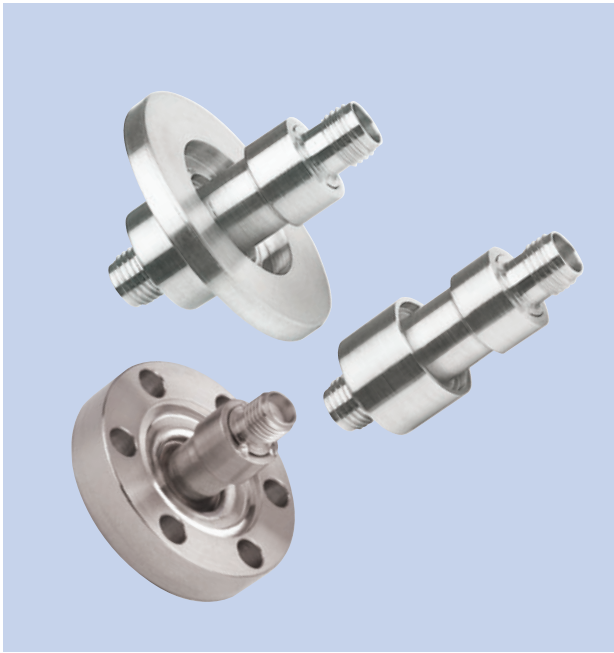

Features

- High-frequency signal transmission to 8GHz
- Air-side connector included
- Three standard vacuum mounting styles
- Custom feedthrough configurations available upon request

Specifications

Voltage¹ 700V DC maximum

Current 3A

Impedance rating 50Ω Matched

Material

Flanges 304ss

Shell 304ss

Pins 304ss

Insulation Alumina ceramic

Vacuum range UHV/HV 1×10^{-10} mbar / 1×10^{-8} mbar

Temperature range²

CF Mounted feedthrough -200°C to 200°C

ISO KF Mounted feedthrough -20°C to 150°C

Weldable feedthrough -200°C to 200°C

Air-side connector -65°C to 165°C

Dimensions Reference only, subject to change

¹ See intended operating parameters in introductory section

² Overall assembly ratings must be adjusted to that of the lowest rated component

UHV and HV series

CF Mount

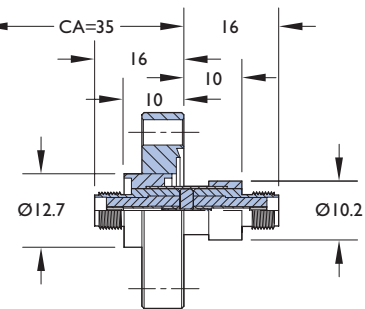

End view Vacuum-side

Figure 1

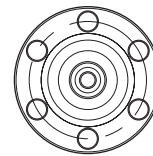

ISO KF Mount

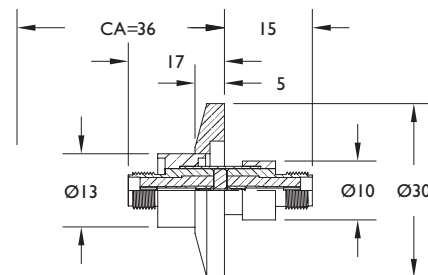

End view Vacuum-side

Figure 2

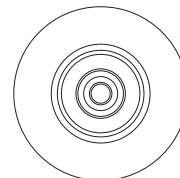

Weldable

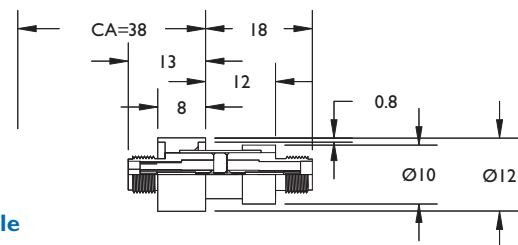

Air-side connector

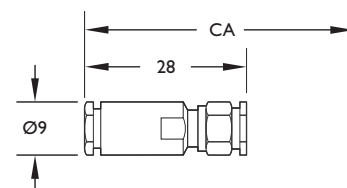

All dimensions are nominal in millimetres unless specified



CF



No. of pins	Flange mount	Reference	Part number
1	DN16CF	SMA50-C16	9252004

Air-side connector included at no extra cost

ISO KF



No. of pins	Flange mount	End view	Reference	Part number
1	K16	2	SMAD-K16	9253004

Air-side connector included at no extra cost

Weldable

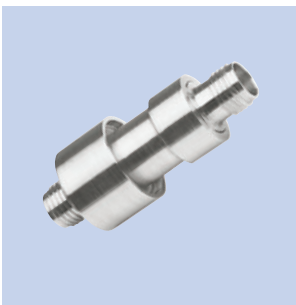

Mount type	Reference	Part number
Double ended	SMAD-50	9251004

Air-side connector included at no extra cost

All dimensions are nominal in millimetres unless specified

**Features**

- Noise shield for instrumentation transmission
- Air-side connector included
- Standard vacuum mounting styles
- Custom feedthrough configurations available upon request
- 3 standard vacuum mount styles

Specifications

Voltage¹	500V DC maximum
Current	2A
Impedance rating	Non constant
Material	
Flanges	304ss
Shell	304ss
Pins	Molybdenum
Insulation	Alumina ceramic
Vacuum range UHV/HV	1×10^{-10} mbar / 1×10^{-8} mbar
Temperature range²	
CF Mounted feedthrough	-100°C to 400°C
ISO KF Mounted feedthrough	-20°C to 150°C
Weldable feedthrough	-100°C to 400°C
Air-side connector	-65°C to 165°C
Dimensions	Reference only, subject to change

¹ See intended operating parameters in introductory section

² Overall assembly ratings must be adjusted to that of the lowest rated component

UHV Series**CF Mount****End view Vacuum-side**

Figure 1

**ISO KF Mount****End view Vacuum-side**

Figure 1

**Weldable****Air-side connector**

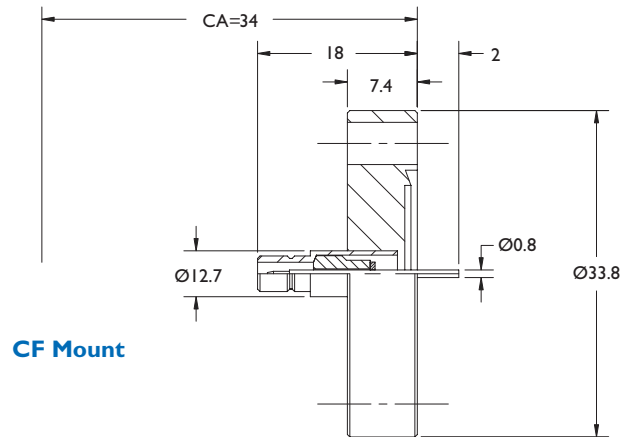
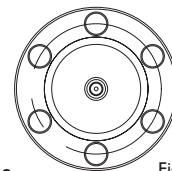
All dimensions are nominal in millimetres unless specified

Microdot® Coaxial

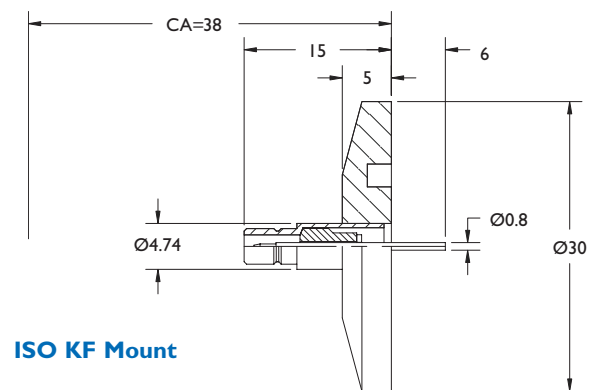
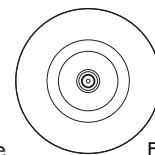
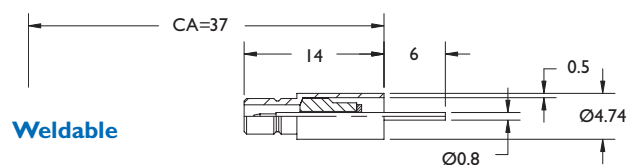
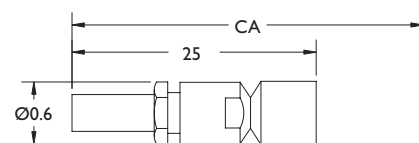
Grounded shield / single ended

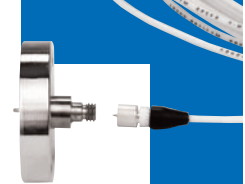

CF



No. of pins	Flange mount	Reference	Part number
1	DNI6CF	SMB0-C16	9252100

Air-side connector included at no extra cost

ISO KF

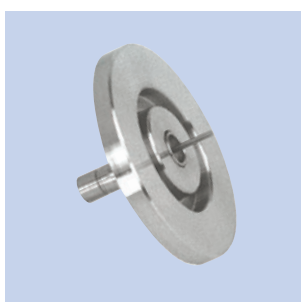

No. of pins	Flange mount	End view	Reference	Part number
1	K075	2	SMB-K16	9253100

Air-side connector included at no extra cost

Weldable



Mount type	Mount dia.	Reference	Part number
Single ended	4.74	SMB	9251100

Air-side connector included at no extra cost

Accessories

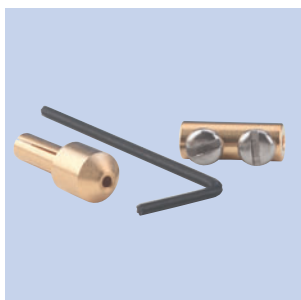

Accessory type	Material	Quantity per pack	Reference	Part number
In-vacuum female contact	Ni-Fe Gold plated	10	DPINFC-10	1510102
In-vacuum male contact	Ni-Fe Gold plated	10	DPINMC-10	1510103
Power, in-line	Be-Cu	10	PIL-059	9924004

All dimensions are nominal in millimetres unless specified

Between series

BNC-Microdot® / crystal sensor feedthrough

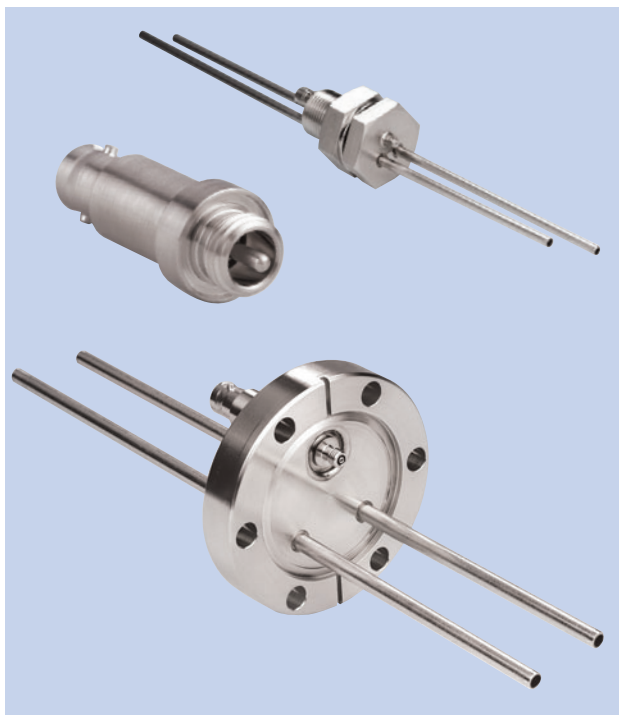

Features

- Noise shield for instrumentation transmission
- Bayonet-style threadless connection for air-side
- Air-side connector included
- In-vacuum cables available See Section 6.7
- Standard vacuum mounting styles
- Custom feedthrough configurations available upon request

Specifications

Voltage¹	500V DC maximum
Current	1A
Impedance rating	Non constant
Material	
Flanges	304ss
Shell	304ss
Pins	304ss
Insulation	Alumina ceramic
Vacuum range UHV/HV	1×10^{-10} mbar / 1×10^{-8} mbar
Temperature range²	
CF Mounted feedthrough	-100°C to 400°C
ISO KF Mounted feedthrough	-20°C to 150°C
Weldable feedthrough	-100°C to 400°C
Air-side connector	-65°C to 165°C
Dimensions	Reference only, subject to change

¹ See intended operating parameters in introductory section

² Overall assembly ratings must be adjusted to that of the lowest rated component

All dimensions are nominal in millimetres unless specified

UHV and HV series

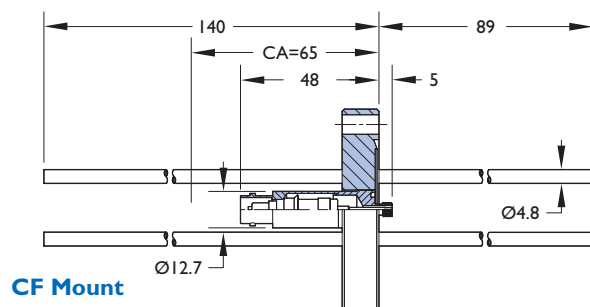

CF Mount

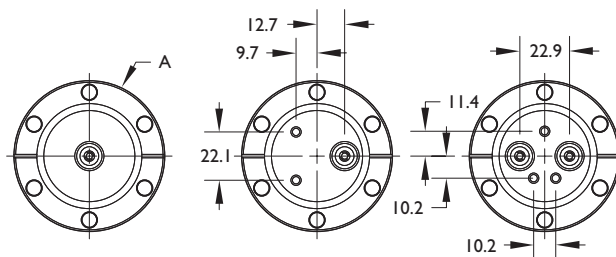
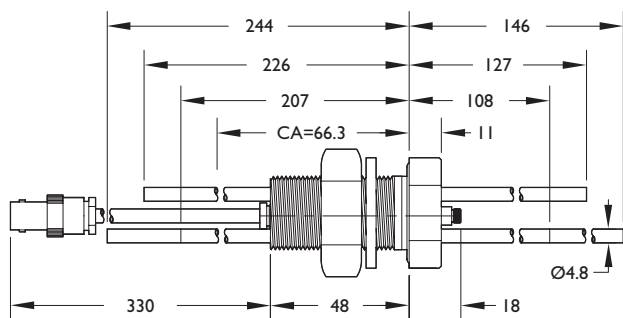

Figure 1

Figure 2

Figure 3

End view



Baseplate mount

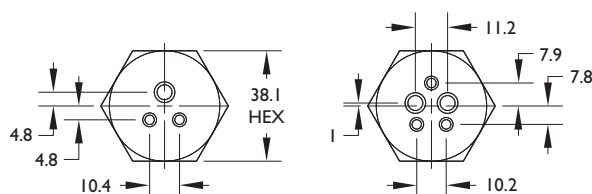

End view

Figure 4

Figure 5

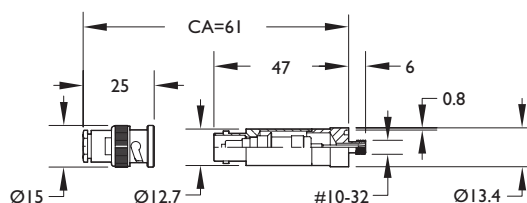

BNC to Microdot®

Between series

BNC-Microdot® / crystal sensor feedthrough



CF



Flange mount	End view figure	Coaxial quantity	Cooling lines quantity	Reference	Part number
DN16CF	1	1	–	BBNCMI-1X-C16	9292194
DN40CF	1	1	–	BBNCMI-1X-C40	9292195
DN40CF	2	1	2	BBNCMI-1X-2L-C40	9292192
DN40CF	3	2	3	BBNCMI-2X-3L-C40	9292193

Baseplate

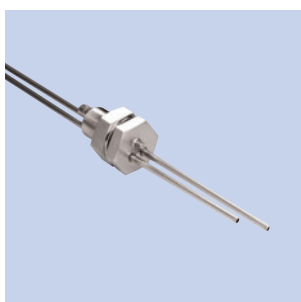

Flange mount	End view figure	Coaxial quantity	Cooling lines quantity	Reference	Part number
1" Baseplate	4	1	2	BBNCMI-1X-2L-B1	9294190
1" Baseplate	5	2	3	BBNCMI-3X-3L-B1	9294191

Weldable



End type	Reference	Part number
BNC-Microdot®	BBNCMI	9291190

Accessories



Accessory type	Quantity per pack	Reference	Part number
Microdot® – Microdot® cable	1	VCR8-MIMI-36	9931313

All dimensions are nominal in millimetres unless specified



Section 6.2

Between series

BNC / MHV-A

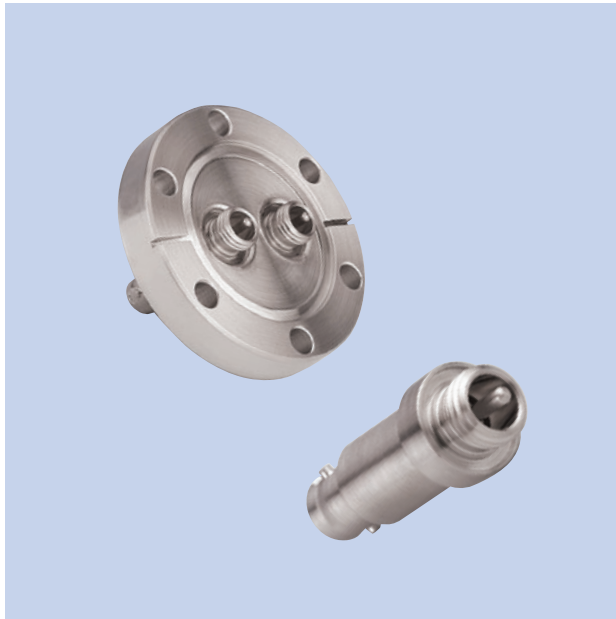

Features

- Noise shield for instrumentation transmission
- Bayonet-style threadless connection for air-side
- Air-side connector included
- In-vacuum cables available [See Section 6.7](#)
- Two standard vacuum mounting styles
- Custom feedthrough configurations available upon request

Specifications

Voltage¹ 500V DC maximum

Current 3A

Impedance rating Non constant

Material

Flanges 304ss

Shell 304ss

Pins 304ss

Insulation Alumina ceramic

Vacuum range UHV/HV 1×10^{-10} mbar / 1×10^{-8} mbar

Temperature range

CF Mounted feedthrough -200°C to 450°C

Weldable feedthrough -200°C to 450°C

Air-side connector -65°C to 165°C

Dimensions Reference only, subject to change

¹ See intended operating parameters in introductory section

² Overall assembly ratings must be adjusted to that of the lowest rated component

UHV Series

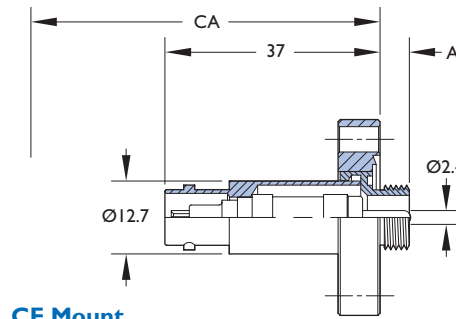

CF Mount

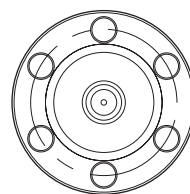

Figure 1

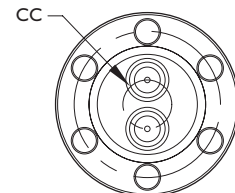
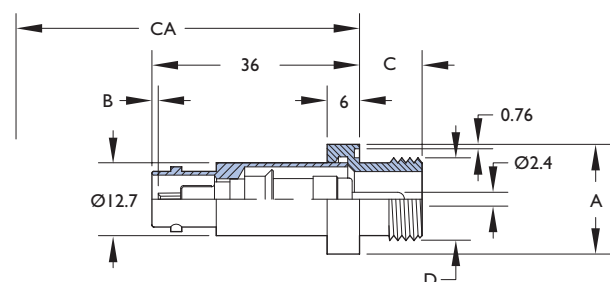
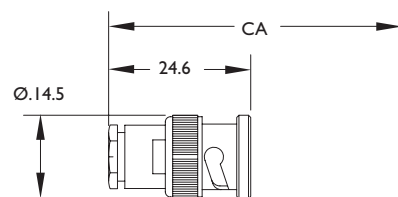

Figure 2

End views Vacuum-side



Weldable



Air-side connector

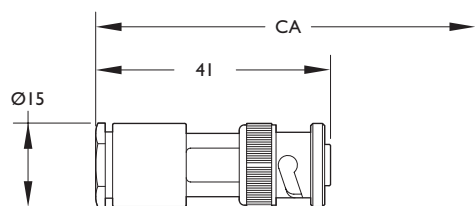

Air-side connector

All dimensions are nominal in millimetres unless specified



CF

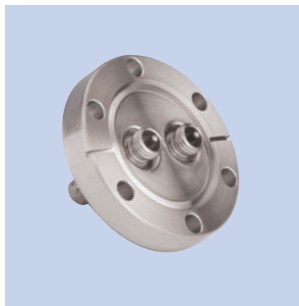

Flange mount	End view figure	No. of pins	A	CA	CC	Reference	Part number
DN16CF	1	1	4.8	53	–	MHV-A8-C16	9292200
DN40CF	2	2	4.8	53	20	MHV-A8-2-C40	9292202
DN40CF	1	1	9.7	68	–	MHV-A4-C40	9292201
DN40CF	2	2	9.7	68	20	MHV-A4-2-C40	9292203

Air-side connector included at no extra cost

Weldable



Flange mount	Cable	A	B	C	CA	D	Reference	Part number
16 dia.	3.9	15.8	3.8/2.5	6.4	51	7/16"-20	BNC-A8	9291100
19 dia.	6.4	18.9	2.2/1.1	11	66	9/16"-18	BNC-A4	9291201

Air-side connector included at no extra cost

Accessories



Accessory type	Terminal	Quantity per pack	Reference	Part number
BNC in-vacuum cable	A-BNC	1	VCR8-ABNC-36	9931305
MVH in-vacuum cable	A-MVH	1	VCR8-AMHV-36	9932312

All dimensions are nominal in millimetres unless specified



Section 6.3

Fibre optics

Feedthroughs

Feedthroughs – electrical and optical

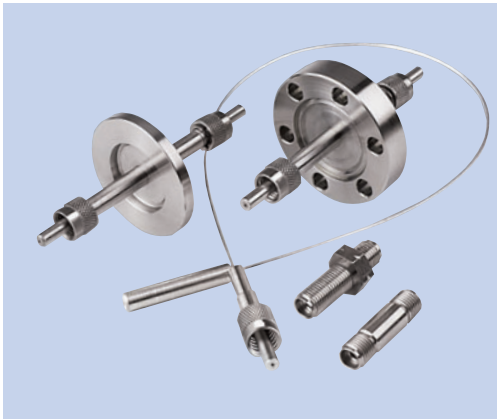

Features

- UHV-compatible materials
- High-temperature rated to 200°C
- Multimode step index fibre
- High-purity synthetic silica
- SMA-905 connector interface
- Brazed seals prevent outgassing
- Doped silica cladding
- Copper metal coating
- Maximum intensity of transmitted power, using a Nd-YAG laser is 100kw/cm² in continuous wave mode and 500kw/cm² in pulses < 1µs
- Feedthrough transmission loss 2db typical

Specifications

Transmission range

UV	180nm to 1200nm
IR	500nm to 2600nm

Attenuation Typical spot values

UV	248nm, KrF laser	<1.2 dB/m
	308nm, XeCl laser	<0.26 dB/m
IR	1.06µm, Nd-YAG laser	<0.01 dB/m

Bend radius

Short term	40 × Fibre radius
Long term	200 × Fibre radius

Numerical aperture

0.22 ± 0.02

Materials

Core	600µm diameter high purity synthetic silica	
Cladding	618µm ± 31µm diameter doped silica	
Core to cladding ratio	1:1.06	
Coating	Copper 165µm ± 65µm thickness	

Vacuum range

UHV/HV 1×10⁻¹⁰/1×10⁻⁸ mbar

Temperature range¹

Feedthrough	200°C
Cable, copper coated	-196 to 200°C

¹ Overall assembly ratings must be adjusted to that of the lowest rated component

Caburn-MDC now provides 600µm fibre optic feedthroughs and accessories which allow fibre optic connections from inside a vacuum system to external instrumentation or energy sources. These high temperature fibre optic products are ideally suited for UHV service in medical, industrial and research applications. UHV fibre optic cable is cleaned and prepared for ultrahigh vacuum service. It is bakeable to 200°C and constructed only from silica and copper. Available in UV or IR

specifications these cables and feedthroughs come complete with SMA-905 connectors or polished and capped ends. The pure silica core provides very low loss and good immunity to radiation damage. Fibres are coated with a layer of copper which gives added strength and high temperature service capabilities. These fibres offer an extended transmission range when compared to conventional silica fibres and are commonly referred to as “Dry” or “Low OH” silica.

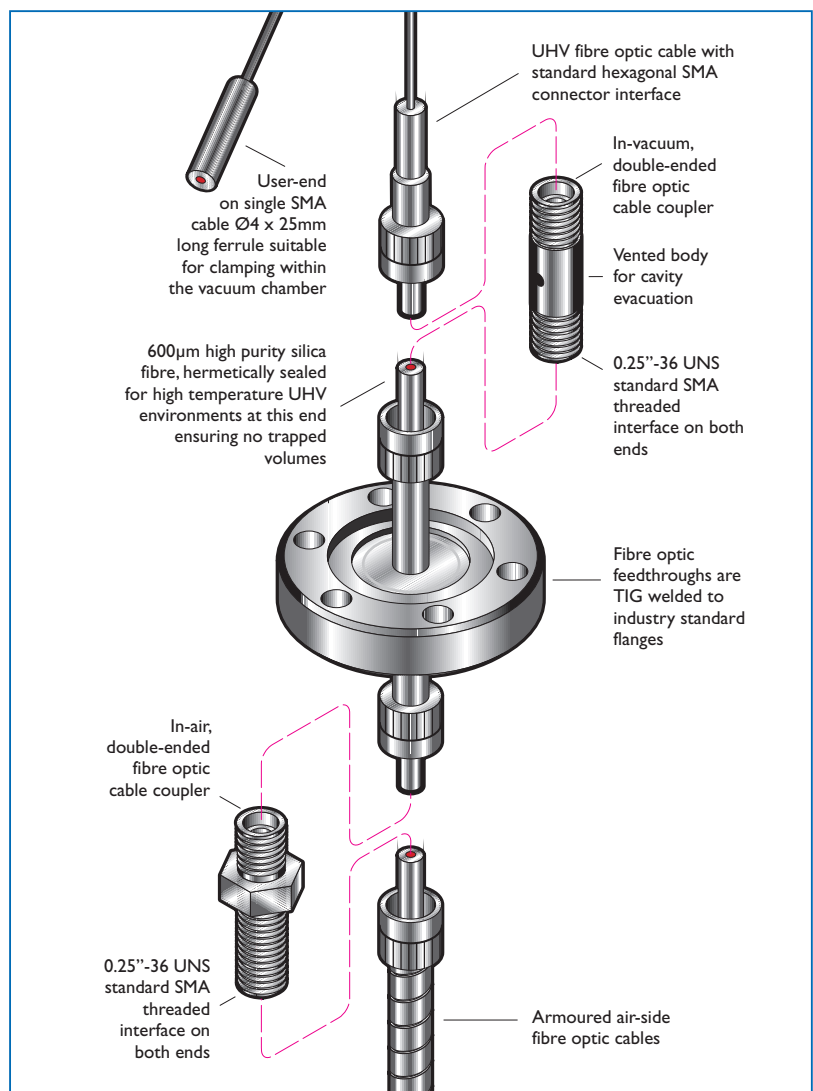

All dimensions are nominal in millimetres unless specified



FFT-IR600-C16



UHV UV and IR fibre optic feedthrough

Fibre mount	Flange	Reference	Part number
UV	DN16CF	FFT-UV600-C16	1513409
UV	DN40CF	FFT-UV600-C40	1513404
IR	DN16CF	FFT-IR600-C16	1513407
IR	DN40CF	FFT-IR600-C40	1513402

FFT-UV600-C40

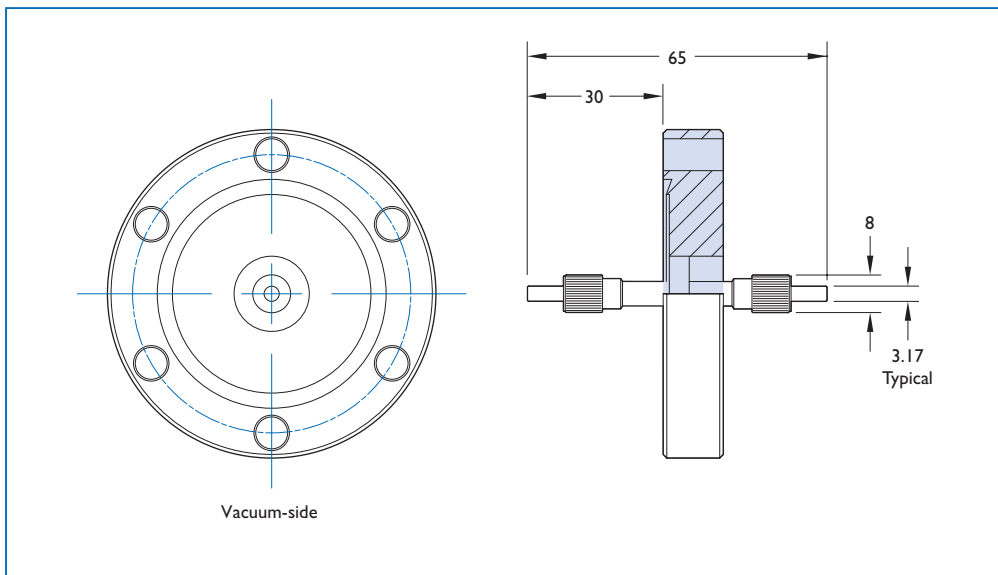

FFT-IR600-K16



HV UV and IR fibre optic feedthrough

Fibre mount	Flange	Dimension A	Reference	Part number
UV	DN16KF	29	FFT-UV600-K16	1513410
UV	DN40KF	31	FFT-UV600-K40	1513405
IR	DN16KF	29	FFT-IR600-K16	1513408
IR	DN40KF	31	FFT-IR600-K40	1513403

FFT-UV600-K40

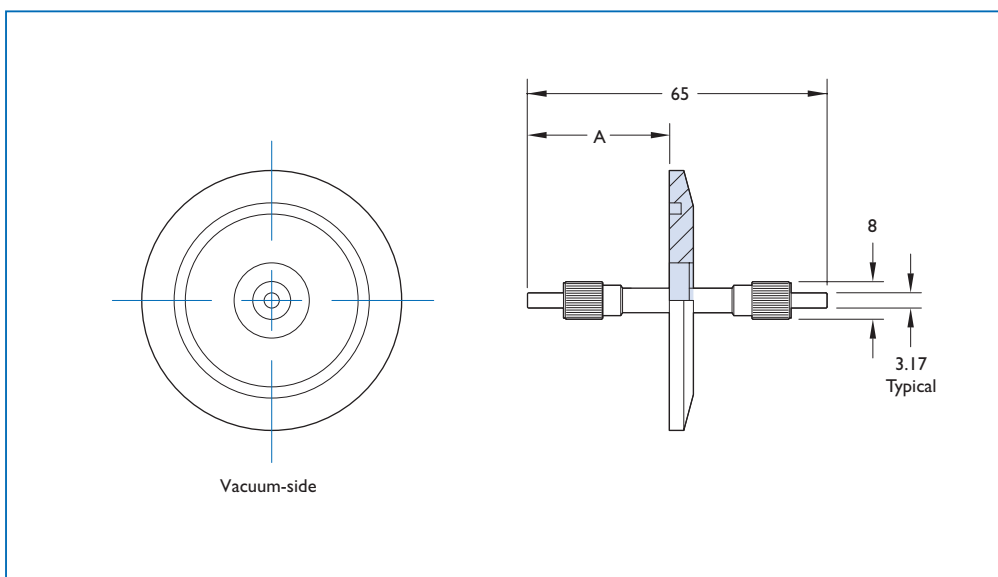

All dimensions are nominal in millimetres unless specified

Thermocouple feedthroughs

Introduction

Caburn-MDC uses the thermocouple classification for all feedthroughs used in applications for temperature measurement.

A thermocouple is a device that measures temperature as a function of the electromotive force induced when heat is applied to two dissimilar metal wires, which are joined at both ends. A thermocouple feedthrough is not a temperature sensing device as such, but a component used to conduct the thermocouple's voltage (EMF) through the bulkhead of a chamber to external instrumentation. A thermocouple feedthrough provides an environmental splice in a thermocouple's conductor path.

Our thermocouple feedthroughs are not thermocouples and are designed for use as accessories or extensions to standard thermocouple elements. Thermocouples are divided into three basic categories: base metal, refractory metal and noble metal types.

Note The following information, although pertinent to thermocouple feedthroughs, is only given as reference for the selection of thermocouples.

Base metal thermocouple – environmental limits

T-type thermocouples with positive copper wires and negative constantan wires are recommended for use in mildly oxidizing and reducing atmospheres. The maximum operating temperature for these alloys is 400°C. These alloys are recommended for low temperature work since the homogeneity of its component wires is better than that in other base metal alloys.

J-type thermocouples with positive iron wires and negative constantan wires are recommended for use in reducing atmospheres. The maximum operating temperature for these alloys is 870°C for the largest wire sizes. Smaller wires should operate in correspondingly lower temperatures.

E-type thermocouples with positive chromel wires and negative constantan wires are recommended for use in vacuum or inert, mildly oxidizing or reducing atmospheres. The maximum operating temperature for these alloys is 870°C. At low temperatures the thermocouple is not subject to corrosion. This thermocouple has the highest EMF output of any standard metallic thermocouple.

K-type thermocouples with positive chromel wires and negative alumel wires are recommended for use in clean oxidizing atmospheres. The maximum operating temperature for these alloys is 1260°C for the largest wire sizes. Smaller wires should operate in correspondingly lower temperatures.

N-type thermocouples with positive nicrosil wire and negative NiSiI wire are used in place of K-type thermocouples where high temperature stability is required. The alloys in this thermocouple offer excellent resistance to preferential oxidation in the range 1000°C to 1200°C. The EMF output differs from that of K-type thermocouples, but the curves have similar slopes over the elevated temperature range.

Refractory metal thermocouple – environmental limits

C-type thermocouples have positive tungsten 5%-rhenium wires and negative tungsten 26%-rhenium wires. These alloys have inherently poor oxidation resistance and are therefore recommended for use in vacuum, hydrogen or inert atmospheres. The maximum operating temperature for this alloy is 2760°C.

Noble metal thermocouple – environmental limits

R-type thermocouples have positive platinum 13% rhodium wires and negative platinum wires. These alloys have a high resistance to oxidation and corrosion. However, hydrogen, carbon and many metal vapours can contaminate these types of thermocouples. The maximum operating temperature for this alloy is 1600°C.

S-type thermocouples have positive platinum 10% rhodium wires and negative platinum wires. These alloys have a high resistance to oxidation and corrosion. However, hydrogen, carbon and many metal vapours can contaminate these types of thermocouples. The maximum operating temperature for this alloy is 1550°C.

The thermocouple application environments presented herein are those recommended by thermocouple manufacturers and suppliers and are provided for reference only. Thermocouple feedthroughs have a maximum temperature rating of 450°C. Furthermore, thermocouple feedthroughs type-C, R and S are manufactured using extension grade thermocouple wire, which is rated for maximum junction temperatures of 250°C.

A thermocouple feedthrough is limited thermally by ceramic to metal joints and vacuum mount style. Ceramic to metal seals should never be subjected to thermal gradients in excess of 25°C per minute.

Intended operating conditions Electrical ratings are safe operating limits. These ratings are determined by various factors, including dielectric strength, geometry and system operating pressure. Please note that all Caburn-MDC catalogue products are electrically rated for operation with one side in dry atmospheric conditions and the other side in a vacuum environment with a maximum system pressure of 1×10^{-4} mbar. We advise that users make allowances for deviations from stated operating parameters and take adequate safety precautions when feedthroughs are operated at high voltages or high currents.

UHV and HV series

Caburn-MDC offers three standard vacuum mount styles: CF, ISO KF and weldable. Additional configurations are available upon request.

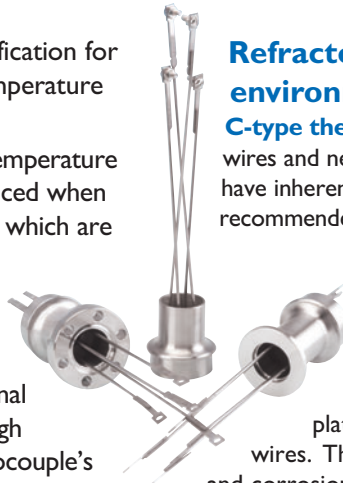





All dimensions are nominal in millimetres unless specified

Thermocouple feedthroughs

Introduction

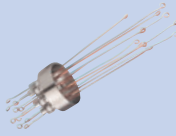

General specifications

Type	Specification voltage/current	Maximum bakeout temperature	Conductor materials	Connector type
 <p>Miniature</p>	Milli-volts (mV) Milli-amps (mA)	CF Flange 450°C ISO KF Flange 150°C Weldable 450°C Connector 125°C	C, E, J, K See table below	Miniature
 <p>Screw type</p>	Milli-volts (mV) Milli-amps (mA)	CF Flange 450°C ISO KF Flange 150°C Weldable 450°C Connector 125°C	R, S, T See table below	Screw type
 <p>MS</p>	Milli-volts (mV) Milli-amps (mA)	CF flange 450°C ISO KF flange 150°C Weldable 450°C Air-side connector 125°C Vacuum-side connector 350°C	E, J, K See table below	MS style
 <p>Push-on</p>	Milli-volts (mV) Milli-amps (mA)	CF flange 450°C ISO KF flange 150°C Weldable 450°C Air-side connector 125°C	E, J, K See table below	Push on
 <p>TC-Power</p>	Power leads: to 5000V DC to 150A TC leads: Milli-volts(mV) Milli-amps (mA)	CF flange 450°C ISO KF flange 150°C Weldable 450°C Air-side connector 125°C	C, E, J, K See table below TC leads C, E, J and K Power leads Cu or Ni	TC-miniature, power in-line or push-on

Thermocouple reference table

ANSI type	Thermocouple pair materials	Polarity	Material type	TC temperature range C	EMF (mV)
T	Copper Constantan®	+ –	Base	-200 to 350	-5.60 to 17.82
J	Iron Constantan®	+ –	Base	0 to 750	0 to 42.28
E	Chromel Constantan®	+ –	Base	0 to 900	-8.82 to 68.78
K	Chromel® Alumel®	+ –	Base	-200 to 1250	-5.97 to 50.63
N	Ni – Cr – Si / Ni – Si – Mg	+ –	Base	-270 to 1300	-4.345 to 47.502
R ¹	Platinum 13% rhodium / platinum	+ –	Noble	0 to 1600	0 to 16.74
S ¹	Platinum 10% rhodium / platinum	+ –	Noble	0 to 1550	0 to 14.97
C ^{1,2}	Tungsten 5% rhenium / tungsten 26% rhenium	+ –	Refractory	0 to 2320	0 to 37.07

¹ Feedthroughs are offered in extension grade wire only (Maximum junction temperature 250°C)

² Not ANSI symbols

All dimensions are nominal in millimetres unless specified

Thermocouple

Miniature connectors – 1 pair



Features

- TC design is compatible with standard miniature connectors
- TC types C, E, J and K are standard – type N available upon request
- Air-side connector included
- In-vacuum accessories available – see section 6.7
- Three standard vacuum mounting styles
- Custom feedthrough configurations available upon request

Specifications

Voltage¹ mV

Current mA

Material

Flanges 304ss

Shell 304ss

Pins See TC options

Insulation Alumina ceramic

Vacuum range UHV/HV 1×10^{-10} mbar / 1×10^{-9} mbar

Temperature range

CF Mounted feedthrough -100°C to 450°C

ISO KF Mounted feedthrough -20°C to 150°C

Weldable feedthrough -100°C to 450°C

Air-side connector -65°C to 165°C

Dimensions Reference only, subject to change

¹ See intended operating parameters in introductory section

² Overall assembly ratings must be adjusted to that of the lowest rated component

UHV and HV series

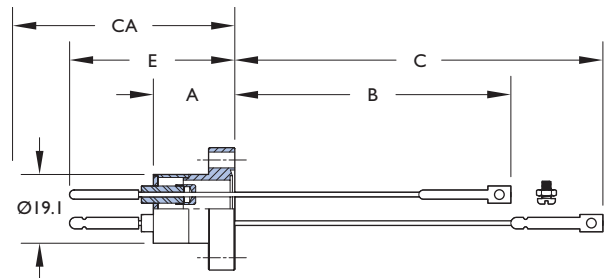

CF Mount

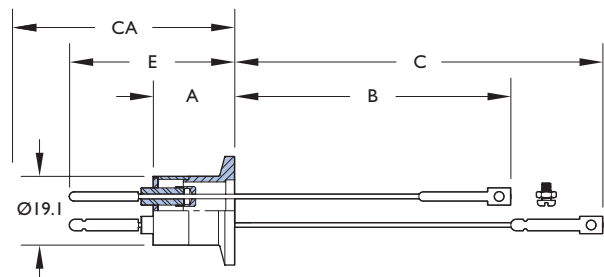

ISO KF Mount

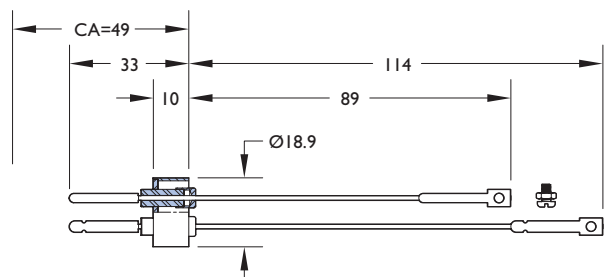

Weldable

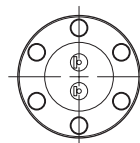

Figure 1

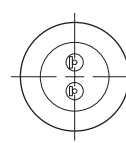

Figure 2

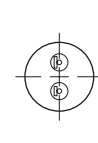
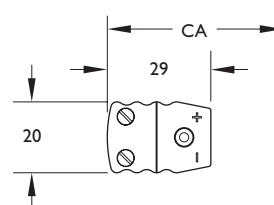

Figure 3

End view Air-side



Air-side connector

All dimensions are nominal in millimetres unless specified

Thermocouple

Miniature connectors – I pair



CF



No. of pairs	Flange mount	End view figure	TC type	A	B	C	E	CA	Reference	Part number
1	DNI6CF	1	C	23	76	102	46	62	TCC-C16	9312000
1	DN40CF	1	C	–	87	112	35	51	TCC-C40	9312027
1	DNI6CF	1	E	23	76	102	46	62	TCE-C16	9312001
1	DNI6CF	1	J	23	76	102	46	62	TCJ-C16	9312002
1	DNI6CF	1	K	23	76	102	46	62	TCK-C16	9312003
1	DN40CF	1	K	–	87	112	35	51	TCK-C40	9312028

Air-side connector included at no extra cost

ISO KF



No. of pairs	Flange mount	End view figure	TC type	A	B	C	E	CA	Reference	Part number
1	DNI6KF	2	C	23	76	102	46	62	TCC-K16	9313000
1	DN40KF	2	C	11	88	113	35	50	TCC-K40	9313027
1	DNI6KF	2	E	23	76	102	46	62	TCE-K16	9313001
1	DNI6KF	2	J	23	76	102	46	62	TCJ-K16	9313002
1	DNI6KF	2	K	23	76	102	46	62	TCK-K16	9313003
1	DN40KF	2	K	11	88	113	35	50	TCK-K40	9313028

Air-side connector included at no extra cost

Weldable

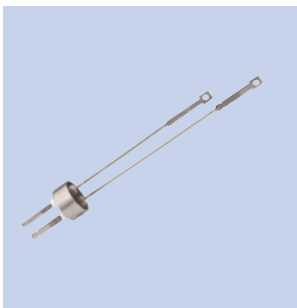

No. of pairs	End view figure	TC type	Reference	Part number
1	3	C	TCC	9311000
1	3	E	TCE	9311001
1	3	J	TCJ	9311002
1	3	K	TCK	9311003

Air-side connector included at no extra cost

All dimensions are nominal in millimetres unless specified

Thermocouple

Miniature connectors – 2 pairs

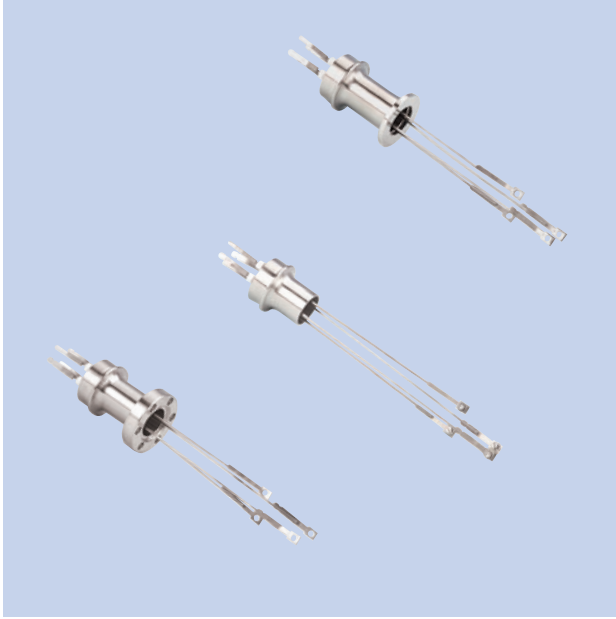

Features

- TC design is compatible with standard miniature connectors
- TC types C, E, J and K are standard – type N available upon request
- Air-side connector included
- In-vacuum accessories available – see section 6.7
- Three standard vacuum mounting styles
- Custom feedthrough configurations available upon request

Specifications

Voltage¹	mV
Current	mA
Material	
Flanges	304ss
Shell	304ss
Pins	See TC options
Insulation	Alumina ceramic
Vacuum range UHV/HV	1×10^{-10} mbar / 1×10^{-8} mbar
Temperature range²	
CF Mounted feedthrough	-100°C to 450°C
ISO KF Mounted feedthrough	-20°C to 150°C
Weldable feedthrough	-100°C to 450°C
Air-side connector	-65°C to 165°C
Dimensions	Reference only, subject to change

¹ See intended operating parameters in introductory section

² Overall assembly ratings must be adjusted to that of the lowest rated component

UHV and HV series

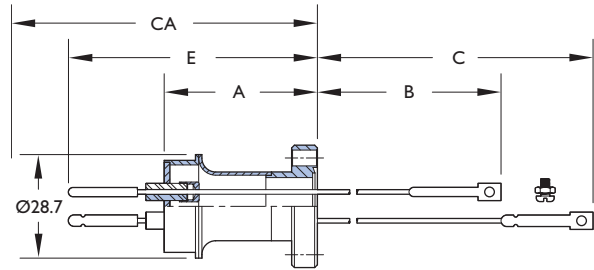

CF Mount

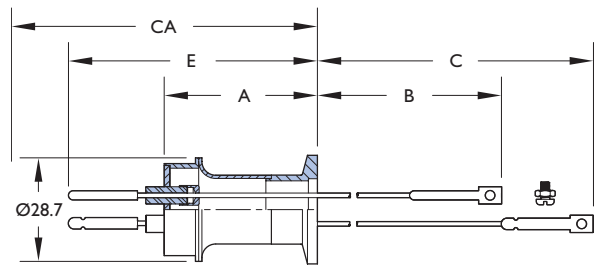

ISO KF Mount

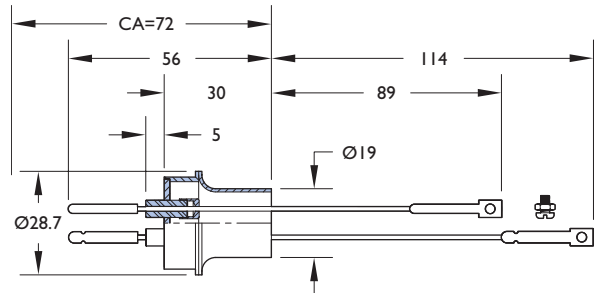

Weldable

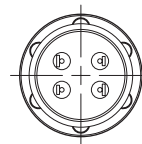

Figure 1

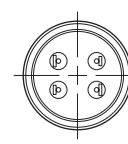

Figure 2

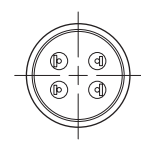
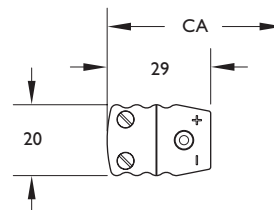

Figure 3

End view Air-side



Air-side connector

All dimensions are nominal in millimetres unless specified

Thermocouple

Miniature connectors – 2 pairs

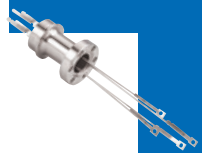

CF



No. of pairs	Flange mount	End view figure	TC type	A	B	C	E	CA	Reference	Part number
2	DNI6CF	I	C	42	76	102	69	84	TCC-2-C16	9312006
2	DN40CF	I	C	32	87	112	58	74	TCC-2-C40	9312029
2	DNI6CF	I	E	42	76	102	69	84	TCE-2-C16	9312007
2	DNI6CF	I	J	42	76	102	69	84	TCJ-2-C16	9312008
2	DNI6CF	I	K	42	76	102	69	84	TCK-2-C16	9312009
2	DN40CF	I	K	32	87	112	58	74	TCK-2-C40	9312030

Air-side connector included at no extra cost

ISO KF



No. of pairs	Flange mount	End view figure	TC type	A	B	C	E	CA	Reference	Part number
2	DNI6KF	2	C	42	76	102	69	84	TCC-2-K16	9313006
2	DN40KF	2	C	30	88	113	57	73	TCC-2-K40	9313029
2	DNI6KF	2	E	42	76	102	69	84	TCE-2-K16	9313007
2	DNI6KF	2	J	42	76	102	69	84	TCJ-2-K16	9313008
2	DNI6KF	2	K	42	76	102	69	84	TCK-2-K16	9313009
2	DN40KF	2	K	30	88	113	57	73	TCK-2-K40	9313030

Air-side connector included at no extra cost

Weldable



No. of pairs	End view figure	TC type	Reference	Part number
2	3	C	TCC-2	9311006
2	3	E	TCE-2	9311007
2	3	J	TCJ-2	9311008
2	3	K	TCK-2	9311009

Air-side connector included at no extra cost

Thermocouple

Miniature connectors – 3 pairs

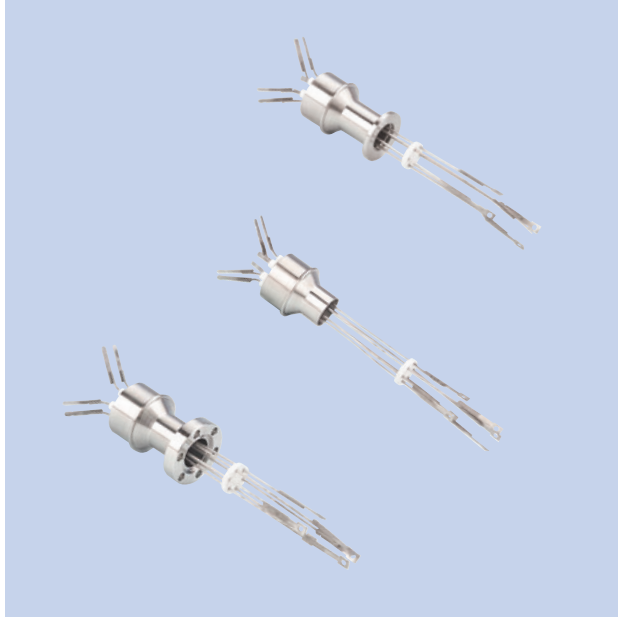

Features

- TC design is compatible with standard miniature connectors
- TC types C, E, J and K are standard – type N available upon request
- Air-side connector included
- In-vacuum accessories available – see section 6.7
- Three standard vacuum mounting styles
- Custom feedthrough configurations available upon request

Specifications

Voltage¹	mV
Current	mA
Material	
Flanges	304ss
Shell	304ss
Pins	See TC options
Insulation	Alumina ceramic
Vacuum range UHV/HV	1×10^{-10} mbar / 1×10^{-8} mbar
Temperature range²	
CF Mounted feedthrough	-100°C to 450°C
ISO KF Mounted feedthrough	-20°C to 150°C
Weldable feedthrough	-100°C to 450°C
Air-side connector	-65°C to 165°C
Dimensions	Reference only, subject to change

¹ See intended operating parameters in introductory section

² Overall assembly ratings must be adjusted to that of the lowest rated component

UHV and HV series

CF Mount

ISO KF Mount

Weldable

Figure 1 Figure 2 Figure 3

End view Air-side

Air-side connector

All dimensions are nominal in millimetres unless specified

Thermocouple

Miniature connectors – 3 pairs

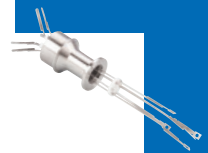

CF



No. of pairs	Flange mount	End view figure	TC type	A	B	C	E	CA	Reference	Part number
3	DNI6CF	1	C	48	76	102	73	87	TCC-3-C16	9312010
3	DN40CF	1	C	37	87	112	62	76	TCC-3-C40	9312031
3	DNI6CF	1	E	48	76	102	73	87	TCE-3-C16	9312011
3	DNI6CF	1	J	48	76	102	73	87	TCJ-3-C16	9312012
3	DNI6CF	1	K	48	76	102	73	87	TCK-3-C16	9312013
3	DN40CF	1	K	37	87	112	62	76	TCK-3-C40	9312032

Air-side connector included at no extra cost

ISO KF

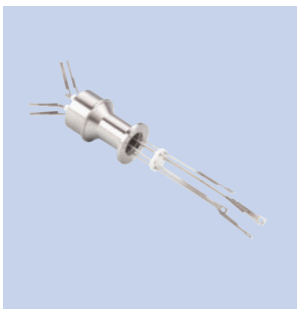

No. of pairs	Flange mount	End view figure	TC type	A	B	C	E	CA	Reference	Part number
3	DNI6KF	2	C	48	76	102	73	87	TCC-3-K16	9313010
3	DN40KF	2	C	36	88	113	61	59	TCC-3-K40	9313031
3	DNI6KF	2	E	48	76	102	73	87	TCE-3-K16	9313011
3	DNI6KF	2	J	48	76	102	73	87	TCJ-3-K16	9313012
3	DNI6KF	2	K	48	76	102	73	87	TCK-3-K16	9313013
3	DN40KF	2	K	36	88	113	61	59	TCK-3-K40	9313032

Air-side connector included at no extra cost

Weldable

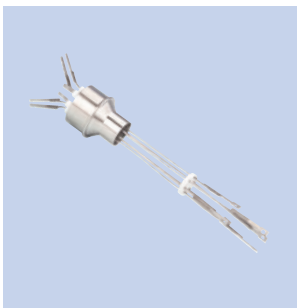

No. of pairs	End view figure	TC type	Reference	Part number
3	3	C	TCC-3	9311010
3	3	E	TCE-3	9311011
3	3	J	TCJ-3	9311012
3	3	K	TCK-3	9311013

Air-side connector included at no extra cost

Thermocouple

Miniature connectors – 4 pairs

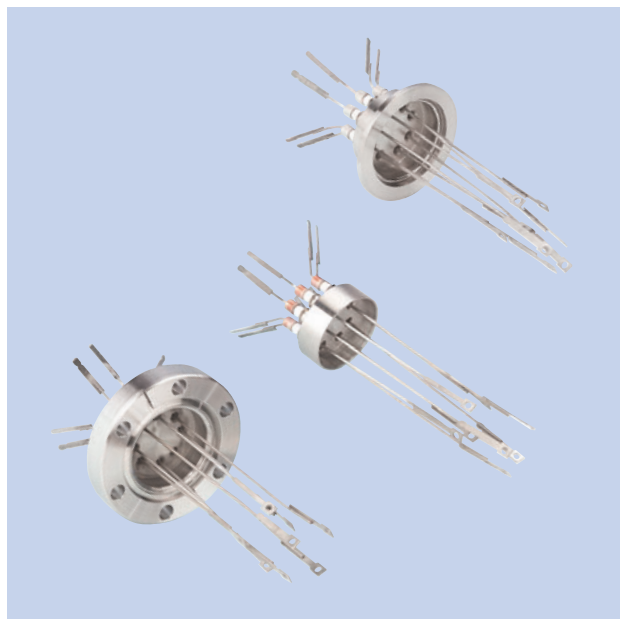

Features

- TC design is compatible with standard miniature connectors
- TC types C, E, J and K are standard – type N available upon request
- Air-side connector included
- In-vacuum accessories available – see section 6.7
- Three standard vacuum mounting styles
- Custom feedthrough configurations available upon request

Specifications

Voltage¹ mV

Current mA

Material

Flanges 304ss

Shell 304ss

Pins See TC options

Insulation Alumina ceramic

Vacuum range UHV/HV 1×10^{-10} mbar / 1×10^{-8} mbar

Temperature range²

CF Mounted feedthrough -100°C to 450°C

ISO KF Mounted feedthrough -20°C to 150°C

Weldable feedthrough -100°C to 450°C

Air-side connector -65°C to 165°C

Dimensions Reference only, subject to change

¹ See intended operating parameters in introductory section

² Overall assembly ratings must be adjusted to that of the lowest rated component

UHV and HV series

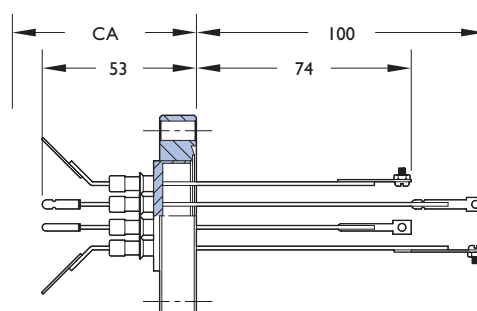

CF Mount

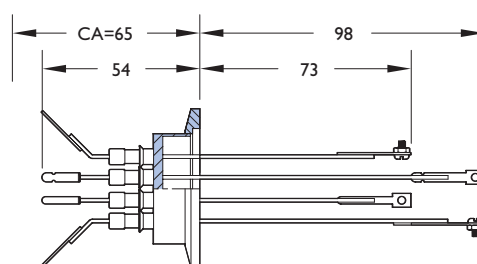

ISO KF Mount

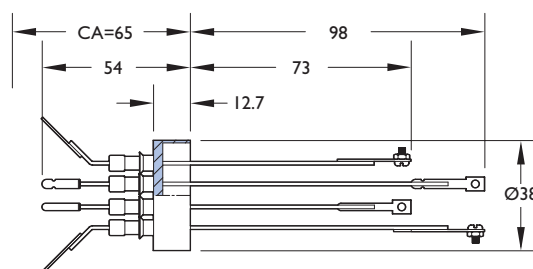

Weldable

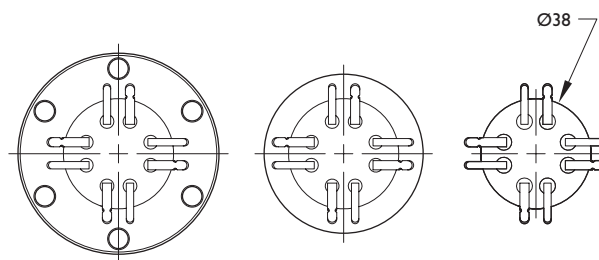
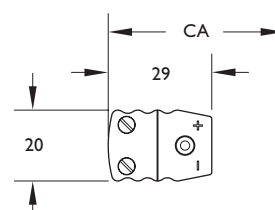

Figure 1

Figure 2

Figure 3

End view Air-side



Air-side connector

All dimensions are nominal in millimetres unless specified

Thermocouple

Miniature connectors – 4 pairs

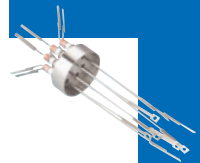

CF



Number of pairs	Flange mount	End view figure	TC type	Reference	Part number
4	DN40CF	I	C	TCC-4-C40	9312014
4	DN40CF	I	E	TCE-4-C40	9312015
4	DN40CF	I	J	TCJ-4-C40	9312016
4	DN40CF	I	K	TCK-4-C40	9312017

Air-side connector included at no extra cost

ISO KF

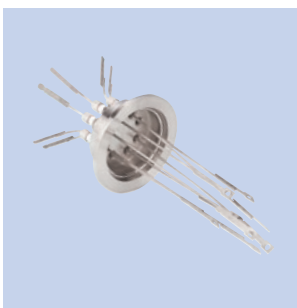

Number of pairs	Flange mount	End view figure	TC type	Reference	Part number
4	DN40KF	2	C	TCC-4-K40	9313014
4	DN40KF	2	E	TCE-4-K40	9313015
4	DN40KF	2	J	TCJ-4-K40	9313016
4	DN40KF	2	K	TCK-4-K40	9313017

Air-side connector included at no extra cost

Weldable

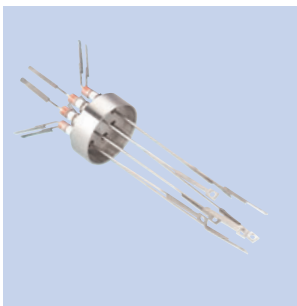

Number of pairs	End view figure	TC type	Reference	Part number
4	3	C	TCC-4	9311014
4	3	E	TCE-4	9311015
4	3	J	TCJ-4	9311016
4	3	K	TCK-4	9311017

Air-side connector included at no extra cost

Thermocouple

Miniature connectors – 5 pairs

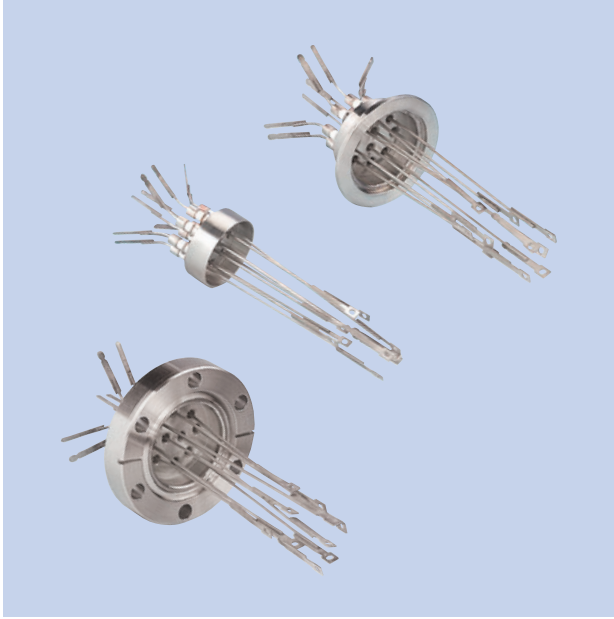

Features

- TC design is compatible with standard miniature connectors
- TC types C, E, J and K are standard – type N available upon request
- Air-side connector included
- In-vacuum accessories available – see section 6.7
- Three standard vacuum mounting styles
- Custom feedthrough configurations available upon request

Specifications

Voltage¹	mV
Current	mA
Material	
Flanges	304ss
Shell	304ss
Pins	See TC options
Insulation	Alumina ceramic
Vacuum range UHV/HV	1×10^{-10} mbar / 1×10^{-8} mbar
Temperature range²	
CF Mounted feedthrough	-100°C to 450°C
ISO KF Mounted feedthrough	-20°C to 150°C
Weldable feedthrough	-100°C to 450°C
Air-side connector	-65°C to 165°C

Dimensions Reference only, subject to change

¹ See intended operating parameters in introductory section

² Overall assembly ratings must be adjusted to that of the lowest rated component

All dimensions are nominal in millimetres unless specified

UHV and HV series

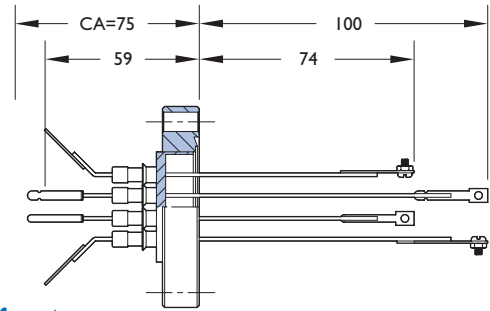

CF Mount

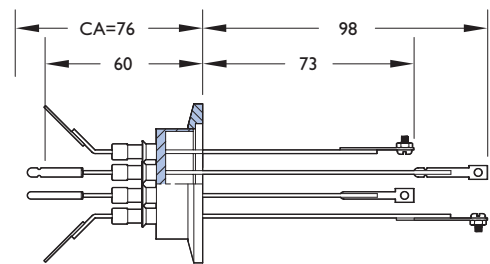

ISO KF Mount

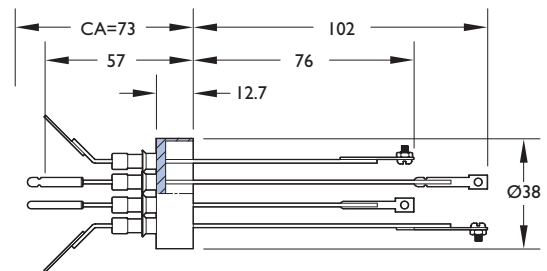

Weldable

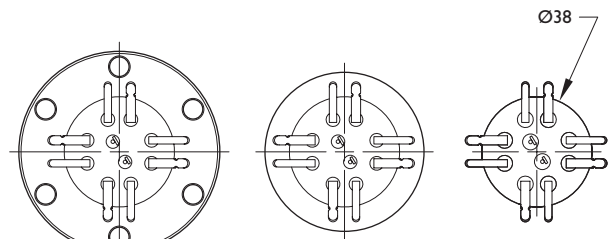
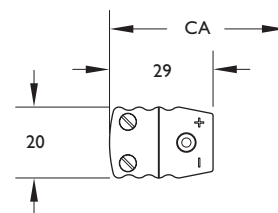

Figure 1

Figure 2

Figure 3

End view Air-side



Air-side connector

Thermocouple

Miniature connectors – 5 pairs

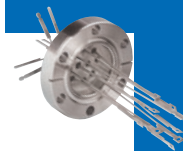

CF

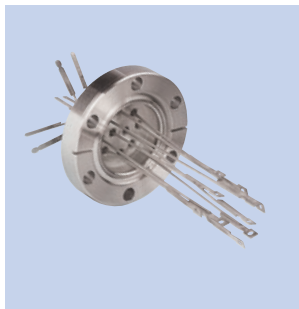

Number of pairs	Flange mount	End view figure	TC type	Reference	Part number
5	DN40CF	I	C	TCC-5-C40	9312018
5	DN40CF	I	E	TCE-5-C40	9312019
5	DN40CF	I	J	TCJ-5-C40	9312020
5	DN40CF	I	K	TCK-5-C40	9312021

Air-side connector included at no extra cost

ISO KF



Number of pairs	Flange mount	End view figure	TC type	Reference	Part number
5	DN40KF	2	C	TCC-5-K40	9313018
5	DN40KF	2	E	TCE-5-K40	9313019
5	DN40KF	2	J	TCJ-5-K40	9313020
5	DN40KF	2	K	TCK-5-K40	9313021

Air-side connector included at no extra cost

Weldable

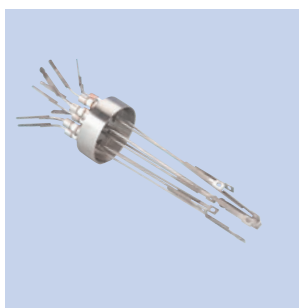

Number of pairs	End view figure	TC type	Reference	Part number
5	3	C	TCC-5	9311018
5	3	E	TCE-5	9311019
5	3	J	TCJ-5	9311020
5	3	K	TCK-5	9311021

Air-side connector included at no extra cost

Thermocouple

Screw type connectors – 1 pair

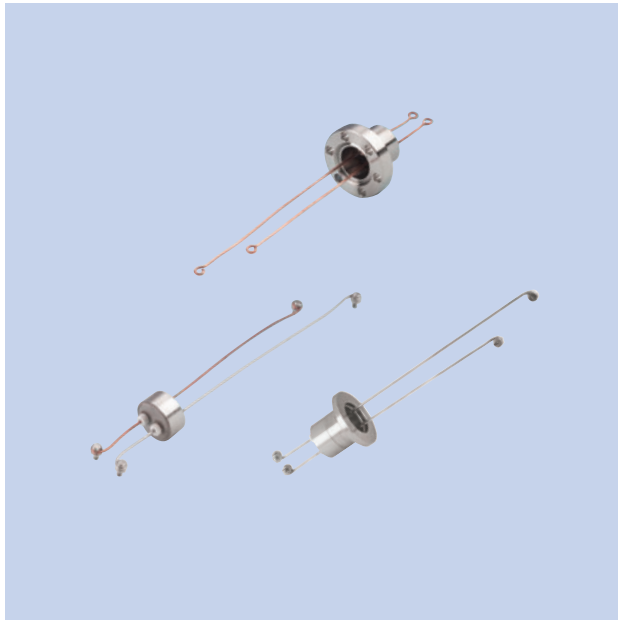

Features

- TC design is compatible with standard screw type connections
- TC types R, S and T are standard – type N available upon request
- In-vacuum accessories available – see section 6.7
- Standard vacuum mounting styles
- Custom feedthrough configurations available upon request

Specifications

Voltage¹ mV

Current mA

Material

Flanges 304ss

Shell 304ss

Pins See TC options

Insulation Alumina ceramic

Vacuum range UHV/HV 1×10^{-10} mbar / 1×10^{-8} mbar

Temperature range²

CF Mounted feedthrough -100°C to 450°C

ISO KF Mounted feedthrough -20°C to 150°C

Weldable feedthrough -100°C to 450°C

Dimensions Reference only, subject to change

¹ See intended operating parameters in introductory section

² Overall assembly ratings must be adjusted to that of the lowest rated component

UHV and HV series

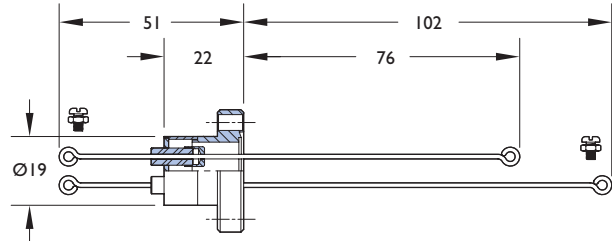

CF Mount

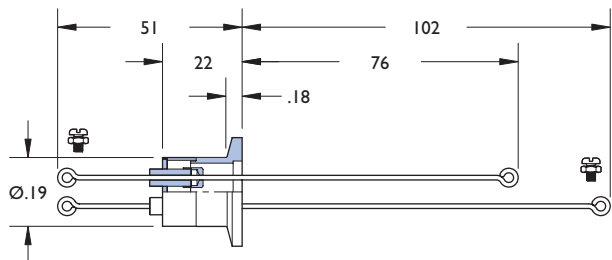

ISO KF Mount

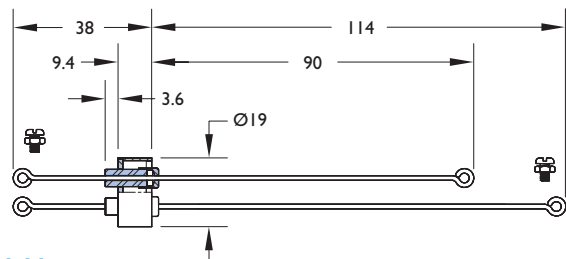

Weldable

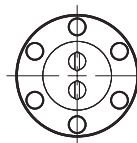

Figure 1

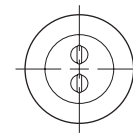

Figure 2



Figure 3

End view Air-side

- Polarity for TC leads is (-) for longer lead and (+) for shorter lead

All dimensions are nominal in millimetres unless specified

Thermocouple

Screw type connectors – 1 pair

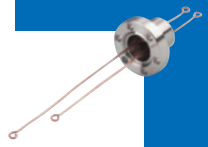

CF



Number of pairs	Flange mount	End view figure	TC type	Reference	Part number
1	DNI6CF	1	R&S	TCR/S-C16	9322012
1	DNI6CF	1	T	TCT-C16	9322013

Air-side connector included at no extra cost

ISO KF

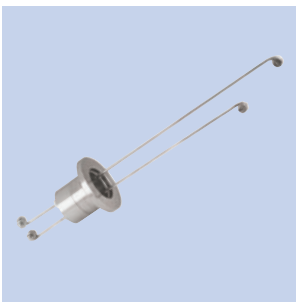

Number of pins	Flange mount	End view	TC type	Reference	Part number
1	DNI6KF	3	R&S	TCR/S-K16	9323012
1	DNI6KF	3	T	TCT-K16	9323013

Weldable

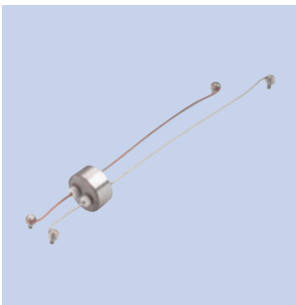

Number of pairs	End view figure	TC type	Reference	Part number
1	2	R&S	TCR/S	9321012
1	3	T	TCT	9321013

Air-side connector included at no extra cost

Section 6.4

Thermocouple

Screw type connectors – 2 pairs

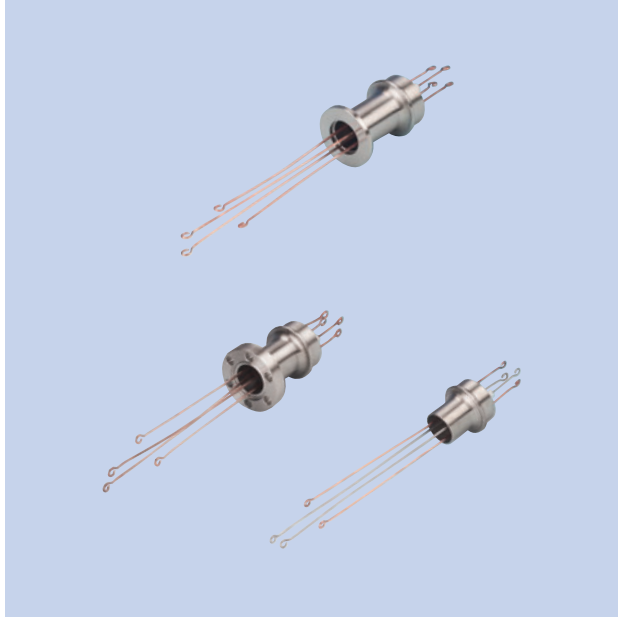

Features

- TC design is compatible with standard screw type connections
- TC types R, S and T are standard – type N available upon request
- In-vacuum accessories available – see section 6.7
- Three standard vacuum mounting styles
- Custom feedthrough configurations available upon request

Specifications

Voltage¹ _____ mV

Current _____ mA

Material

Flanges 304ss

Shell 304ss

Pins See TC options

Insulation Alumina ceramic

Vacuum range UHV/HV 1×10^{-10} mbar / 1×10^{-8} mbar

Temperature range²

CF Mounted feedthrough -100°C to 450°C

ISO KF Mounted feedthrough -20°C to 150°C

Weldable feedthrough -100°C to 450°C

Dimensions Reference only, subject to change

¹ See intended operating parameters in introductory section

² Overall assembly ratings must be adjusted to that of the lowest rated component

UHV and HV series

CF Mount

ISO KF Mount

Weldable

Figure 1 Figure 2 Figure 3

End view Air-side

■ Polarity for TC leads is (-) for longer lead and (+) for shorter lead

All dimensions are nominal in millimetres unless specified

Thermocouple

Screw type connectors – 2 pairs

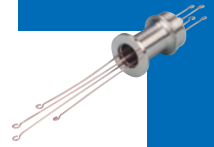

CF



Number of pairs	Flange mount	End view figure	TC type	Reference	Part number
2	DNI6CF	I	R&S	TCR/S-2-CI6	9322014
2	DNI6CF	I	T	TCT-2-CI6	9322015

Air-side connector included at no extra cost

ISO KF



Number of pairs	Flange mount	End view figure	TC type	Reference	Part number
2	DNI6KF	2	R&S	TCR/S-2-KI6	9323014
2	DNI6KF	2	T	TCT-2-KI6	9323015

Air-side connector included at no extra cost

Weldable



Number of pairs	End view figure	TC type	Reference	Part number
2	3	R&S	TCR/S-2	9321014
2	3	T	TCT-2	9321015

Air-side connector included at no extra cost

All dimensions are nominal in millimetres unless specified

Thermocouple

Screw type connectors – 3 pairs

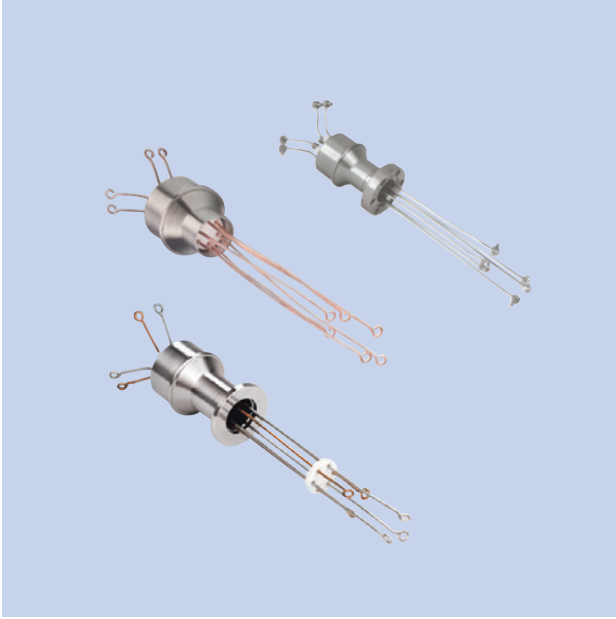
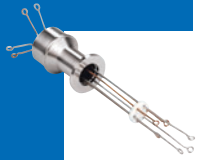

Features

- TC design is compatible with standard screw type connections
- TC types R, S and T are standard – type N available upon request
- In-vacuum accessories available – see section 6.7
- Standard vacuum mounting styles
- Custom feedthrough configurations available upon request

Specifications

Voltage¹	mV
Current	mA
Material	
Flanges	304ss
Shell	304ss
Pins	See TC options
Insulation	Alumina ceramic
Vacuum range UHV/HV	1×10^{-10} mbar / 1×10^{-8} mbar
Temperature range²	
CF Mounted feedthrough	-100°C to 450°C
ISO KF Mounted feedthrough	-20°C to 150°C
Weldable feedthrough	-100°C to 450°C
Dimensions	Reference only, subject to change

¹ See intended operating parameters in introductory section

² Overall assembly ratings must be adjusted to that of the lowest rated component

All dimensions are nominal in millimetres unless specified

UHV and HV series

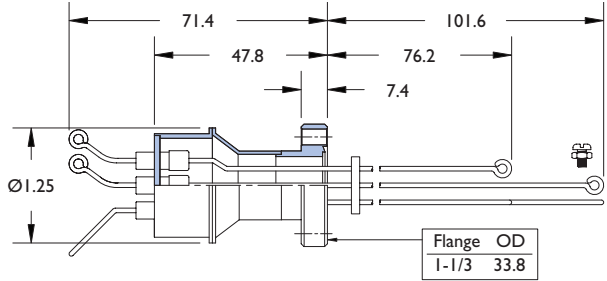

CF Mount

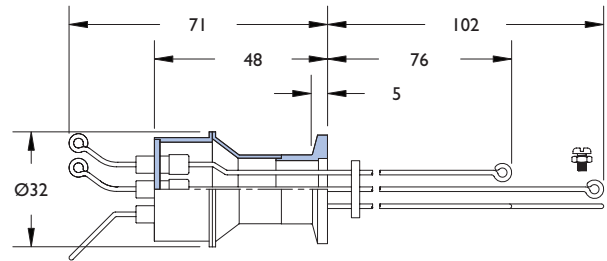

ISO KF Mount

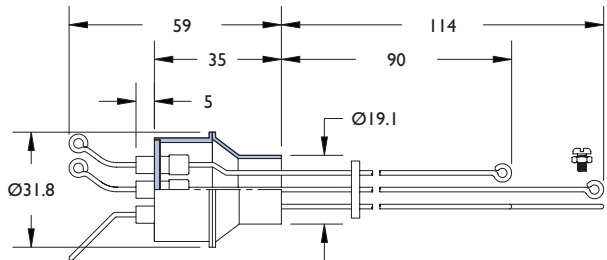

Weldable

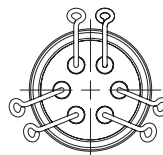

Figure 1

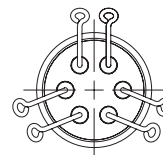

Figure 2

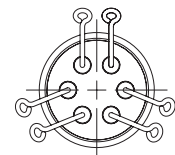

Figure 3

End view Air-side

- Polarity for TC leads is (-) for longer lead and (+) for shorter lead

Thermocouple

Screw type connectors – 3 pairs

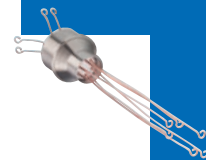

CF

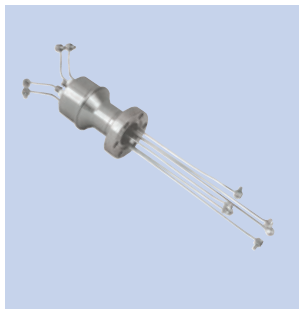

Number of pairs	Flange mount	End view figure	TC type	Reference	Part number
3	DNI6CF	I	R&S	TCR/S-3-CI6	9322016
3	DNI6CF	I	T	TCT-3-CI6	9322017

Air-side connector included at no extra cost

ISO KF

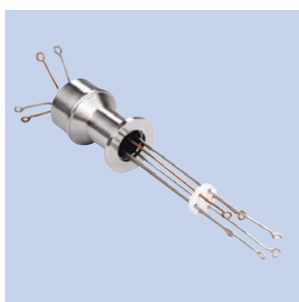

Number of pins	Flange mount	End view figure	TC type	Reference	Part number
3	DNI6KF	2	R&S	TCR/S-3-KI6	9323016
3	DNI6KF	2	T	TCT-3-KI6	9323017

Weldable

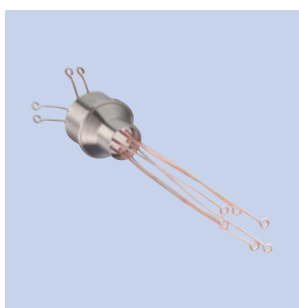

Number of pairs	End view figure	TC type	Reference	Part number
3	3	R&S	TCR/S-3	9321016
3	3	T	TCT-3	9321017

Air-side connector included at no extra cost

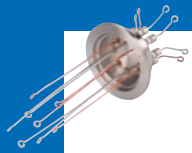

Section 6.4

Thermocouple

Screw type connectors – 4 pairs

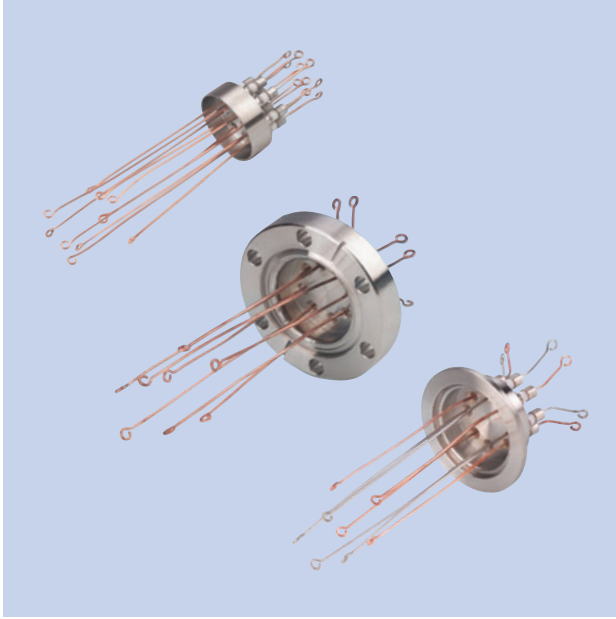

Features

- TC design is compatible with standard screw type connections
- TC types R, S and T are standard – type N available upon request
- In-vacuum accessories available – see section 6.7
- Three standard vacuum mounting styles
- Custom feedthrough configurations available upon request

Specifications

Voltage¹	mV
Current	mA
Material	
Flanges	304ss
Shell	304ss
Pins	See TC options
Insulation	Alumina ceramic
Vacuum range UHV/HV	1×10^{-10} mbar / 1×10^{-8} mbar
Temperature range²	
CF Mounted feedthrough	-100°C to 450°C
ISO KF Mounted feedthrough	-20°C to 150°C
Weldable feedthrough	-100°C to 450°C

Dimensions Reference only, subject to change

¹ See intended operating parameters in introductory section

² Overall assembly ratings must be adjusted to that of the lowest rated component

UHV and HV series

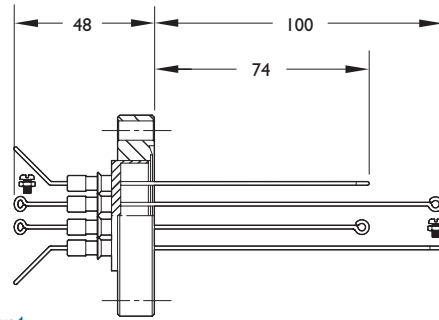

CF Mount

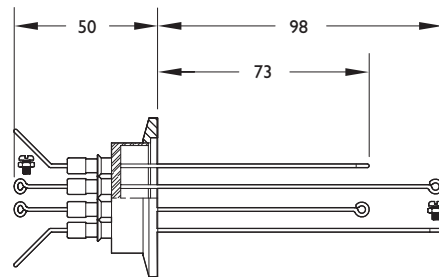

ISO KF Mount

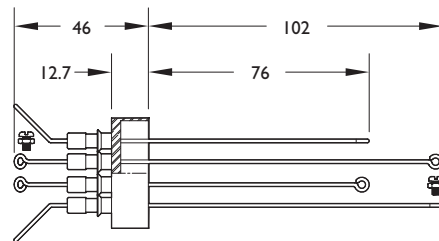

Weldable

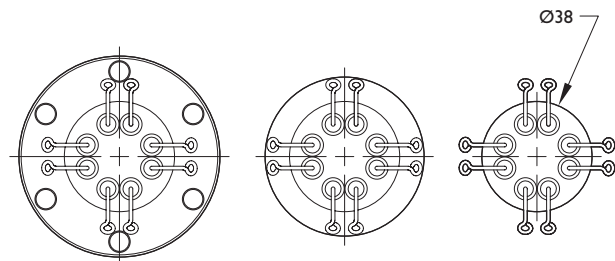

Figure 1

Figure 2

Figure 3

Air-side connector

- Polarity for TC leads is (-) for longer lead and (+) for shorter lead

All dimensions are nominal in millimetres unless specified

Thermocouple

Screw type connectors – 4 pairs

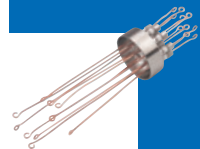

CF

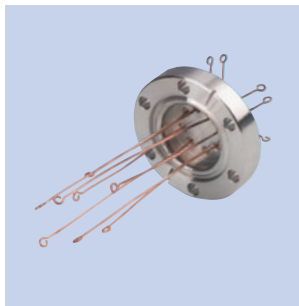

Number of pairs	Flange mount	End view figure	TC type	Reference	Part number
4	DN40CF	I	R&S	TCR/S-4-C40	9322018
4	DN40CF	I	T	TCT-4-C40	9322019

Air-side connector included at no extra cost

ISO KF

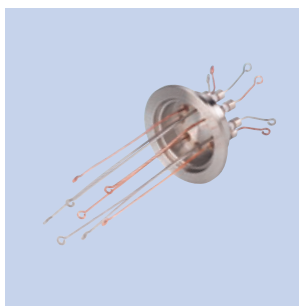

Number of pairs	Flange mount	End view figure	TC type	Reference	Part number
4	DN40KF	2	R&S	TCR/S-4-K40	9323018
4	DN40KF	2	T	TCT-4-K40	9323019

Air-side connector included at no extra cost

Weldable

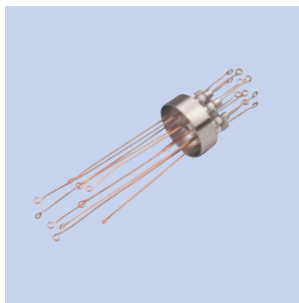

Number of pairs	End view figure	TC type	Reference	Part number
4	3	R&S	TCR/S-4	9321018
4	3	T	TCT-4	9321019

Air-side connector included at no extra cost

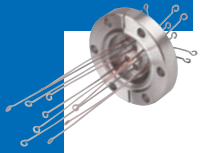

Thermocouple

Screw type connectors – 5 pairs

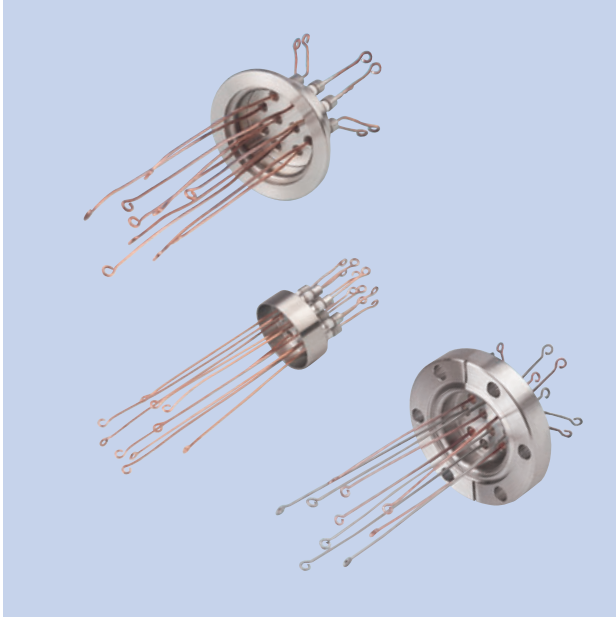

Features

- TC design is compatible with standard screw type connections
- TC types R, S and T are standard – type N available upon request
- In-vacuum accessories available – see section 6.7
- Standard vacuum mounting styles
- Custom feedthrough configurations available upon request

Specifications

Voltage¹	mV
Current	mA
Material	
Flanges	304ss
Shell	304ss
Pins	See TC options
Insulation	Alumina ceramic
Vacuum range UHV/HV	1×10^{-10} mbar / 1×10^{-8} mbar
Temperature range²	
CF Mounted feedthrough	-100°C to 450°C
ISO KF Mounted feedthrough	-20°C to 150°C
Weldable feedthrough	-100°C to 450°C
Dimensions	Reference only, subject to change

¹ See intended operating parameters in introductory section

² Overall assembly ratings must be adjusted to that of the lowest rated component

UHV and HV series

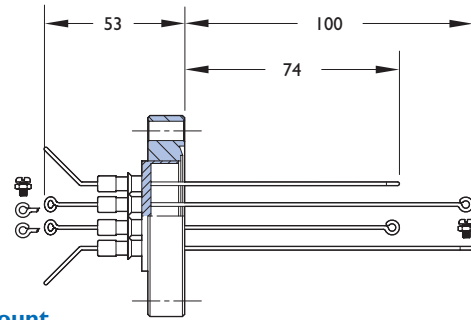

CF Mount

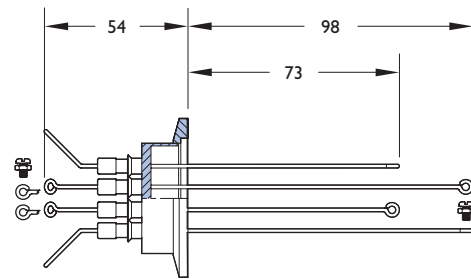

ISO KF Mount

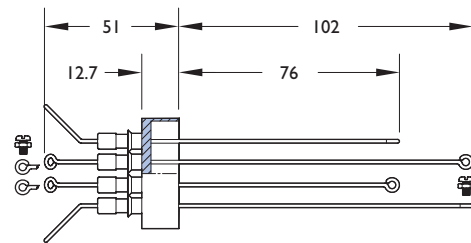

Weldable

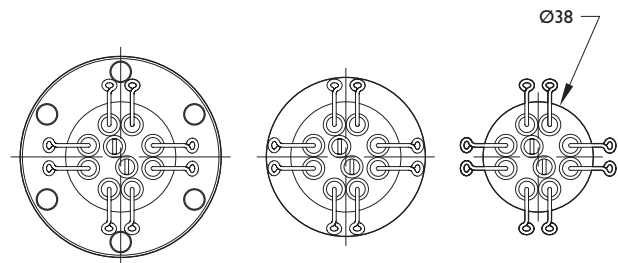

Figure 1

Figure 2

Figure 3

Air-side connector

- Polarity for TC leads is (-) for longer lead and (+) for shorter lead

All dimensions are nominal in millimetres unless specified

Thermocouple

Screw type connectors – 5 pairs

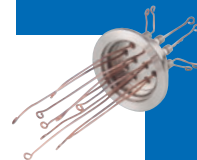

CF

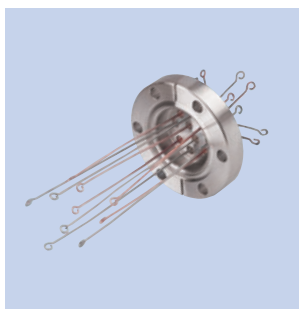

Number of pairs	Flange mount	End view figure	TC type	Reference	Part number
5	DN40CF	I	R&S	TCR/S-5-C40	9322020
5	DN40CF	I	T	TCT-5-C40	9322021

Air-side connector included at no extra cost

ISO KF

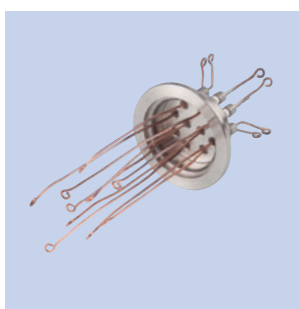

Number of pairs	Flange mount	End view figure	TC type	Reference	Part number
5	DN40KF	2	R&S	TCR/S-5-K40	9323020
5	DN40KF	2	T	TCT-5-K40	9323021

Air-side connector included at no extra cost

Weldable

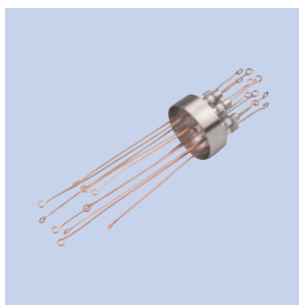

Number of pairs	End view figure	TC type	Reference	Part number
5	3	R&S	TCR/S-5	9321020
5	3	T	TCT-5	9321021

Air-side connector included at no extra cost

All dimensions are nominal in millimetres unless specified

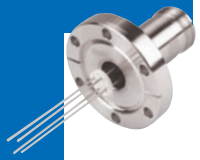

Thermocouple

MS Connectors



Features

- TC design is compatible with standard threaded connectors
- TC type K is standard – types E and J available upon request
- Air-side connector included
- In-vacuum accessories available – see section 6.7
- Three standard vacuum mounting styles
- Custom feedthrough configurations available upon request
- Ceramic spacers available – see page 296

Specifications

Voltage¹	mV
Current	mA
Material	
Flanges	304ss
Shell	304ss
Pins	See TC options
Insulation	Alumina ceramic
Vacuum range UHV/HV	1×10^{-10} mbar / 1×10^{-8} mbar
Temperature range²	
CF Mounted feedthrough	-100°C to 450°C
ISO KF Mounted feedthrough	-20°C to 150°C
Weldable feedthrough	-100°C to 450°C
Air-side connector	-65°C to 165°C

Dimensions Reference only, subject to change

¹ See intended operating parameters in introductory section

² Overall assembly ratings must be adjusted to that of the lowest rated component

All dimensions are nominal in millimetres unless specified

UHV and HV series

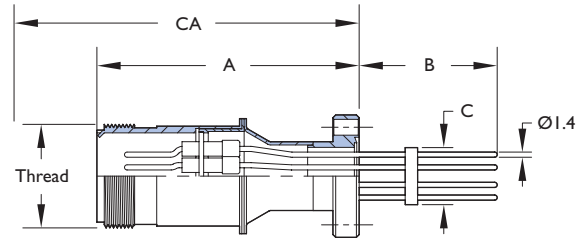

CF Mount

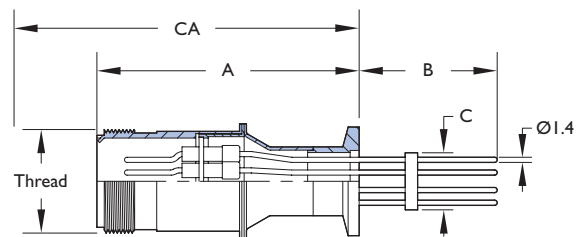

ISO KF Mount

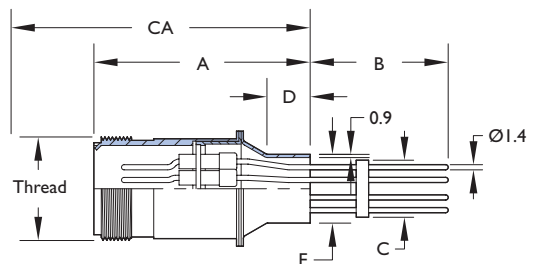

Weldable

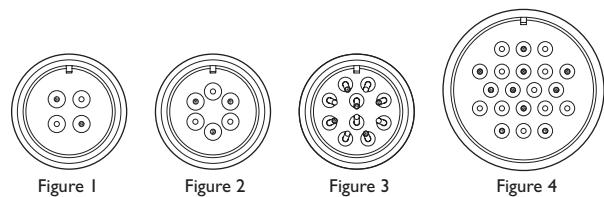

End view Air-side

- Polarity for TC leads is ○ for (-), and for ● (+)

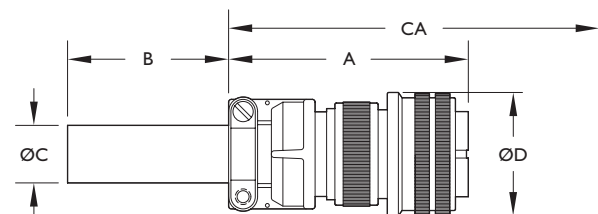

Air-side connector

Thermocouple

MS Connectors



CF



No. of pairs	Flange mount	End view figure	TC type	A	B	C	Thread	CA	Reference	Part number
2	DNI6CF	1	K	69	69	16	1/8"-18	115	MSK-2-C16	9332008
2	DN40CF	1	K	57	80	16	1/8"-18	104	MSK-2-C40	9332011
3	DNI6CF	2	K	69	69	16	1/8"-18	115	MSK-3-C16	9332014
3	DN40CF	2	K	57	80	16	1/8"-18	104	MSK-3-C40	9332017
5	DNI6CF	3	K	69	69	16	1/8"-18	115	MSK-5-C16	9332020
5	DN40CF	3	K	57	80	16	1/8"-18	104	MSK-5-C40	9332023
10	DN40CF	4	K	66	88	32	3/4"-18	123	MSK-10-C40	9332026

Air-side connector included at no extra cost

ISO KF



No. of pairs	Flange mount	End view figure	TC type	A	B	C	Thread	CA	Reference	Part number
2	DNI6KF	1	K	69	69	16	1/8"-18	115	MSK-2-K16	9333008
2	DN40KF	1	K	56	81	16	1/8"-18	102	MSK-2-K40	9333011
3	DNI6KF	2	K	69	69	16	1/8"-18	115	MSK-3-K16	9333014
3	DN40KF	2	K	56	81	16	1/8"-18	102	MSK-3-K40	9333017
5	DNI6KF	3	K	69	69	16	1/8"-18	115	MSK-5-K16	9333020
5	DN40KF	3	K	56	81	16	1/8"-18	102	MSK-5-K40	9333023
10	DN40KF	4	K	64	89	32	3/4"-18	121	MSK10-K40	9333026

Air-side connector included at no extra cost

Weldable



No. of pairs	End view figure	TC type	A	B	C	D	E	Thread	CA	Reference	Part number
2	1	K	60	81	16	12	19	1/8"-18	102	MSK-2	9331008
3	2	K	60	81	16	12	19	1/8"-18	102	MSK-3	9331011
5	3	K	60	81	16	12	19	1/8"-18	102	MSK-5	9331014
10	4	K	60	89	32	19	35	3/4"-18	121	MSK-10	9331017

Air-side connector included at no extra cost

All dimensions are nominal in millimetres unless specified



Thermocouple

MS Connectors



Features

- TC design is compatible with standard threaded connectors
- TC type K is standard – types E and J available upon request
- Air-side connector included
- In-vacuum accessories available – see section 6.7
- Three standard vacuum mounting styles
- Custom feedthrough configurations available upon request

Specifications

Voltage¹	mV
Current	mA
Material	
Flanges	304ss
Shell	304ss
Pins	See TC options
Insulation	Alumina ceramic
Vacuum range UHV/HV	1×10^{-10} mbar / 1×10^{-8} mbar
Temperature range²	
CF Mounted feedthrough	-100°C to 450°C
ISO KF Mounted feedthrough	-20°C to 150°C
Weldable feedthrough	-100°C to 450°C
Air and vacuum-side connectors	-100°C to 350°C
Dimensions	Reference only, subject to change

¹ See intended operating parameters in introductory section

² Overall assembly ratings must be adjusted to that of the lowest rated component

All dimensions are nominal in millimetres unless specified

UHV Series

CF Mount

Flange OD	
2-3/4	69.3
4-1/2	114

ISO KF Mount

Weldable

End view Air-side

- Polarity for TC leads is ○ for (-), and for ● (+)

Air-side connector



CF



End type	Flange mount	End view figure	TC type	A	B	Thread	CA	CV	Reference	Part number
2	DN40CF	1	K	61	87	1 1/8"-18	108	134	MSDK-2-C40	9332029
3	DN40CF	2	K	61	87	1 1/8"-18	108	134	MSDK-3-C40	9332032
5	DN40CF	3	K	61	87	1 1/8"-18	108	134	MSDK-5-C40	9332035
10	DN63CF	4	K	72	87	1 3/4"-18	129	145	MSDK-10-C63	9332038

Air-side connector included at no extra cost

ISO KF



End type	Flange mount	End view figure	TC type	A	B	Thread	CA	CV	Reference	Part number
2	DN40CF	1	K	62	86	1 1/8"-18	109	133	MSDK-2-K40	9333029
3	DN40CF	2	K	62	86	1 1/8"-18	109	133	MSDK-3-K40	9333035
5	DN40CF	3	K	62	86	1 1/8"-18	109	133	MSDK-5-K40	9333041

Air-side connector included at no extra cost

Weldable



No. of pairs	End view figure	TC type	A	B	C	D	Thread	CA	CV	Reference	Part number
2	1	K	60	89	8	35	1 1/8"-18	106	135	MSDK-2	9331020
3	2	K	60	89	8	35	1 1/8"-18	106	135	MSDK-3	9331023
5	3	K	60	89	8	35	1 1/8"-18	106	135	MSDK-5	9331026
10	4	K	71	89	9	63	1 3/4"-18	128	146	MSDK-10	9331029

Air-side connector included at no extra cost

Thermocouple

Push-on connectors

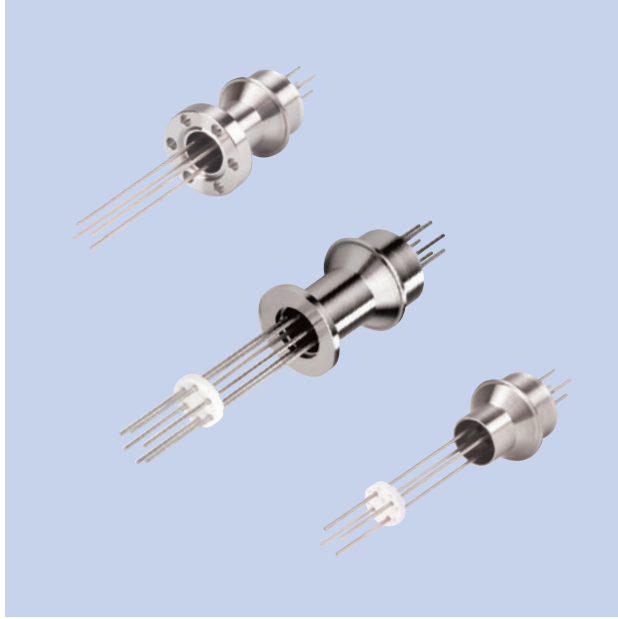

Features

- TC type K is standard – types E and J available upon request
- Air-side connector included
- In-vacuum accessories available – see section 6.7
- Three standard vacuum mounting styles
- Custom feedthrough configurations available upon request

Specifications

Voltage¹	mV
Current	mA
Material	
Flanges	304ss
Shell	304ss
Pins	See TC options
Insulation	Alumina ceramic
Vacuum range UHV/HV	1×10^{-10} mbar / 1×10^{-8} mbar
Temperature range²	
CF Mounted feedthrough	-100°C to 450°C
ISO KF Mounted feedthrough	-20°C to 150°C
Weldable feedthrough	-100°C to 450°C

Dimensions Reference only, subject to change

¹ See intended operating parameters in introductory section

² Overall assembly ratings must be adjusted to that of the lowest rated component

UHV and HV series

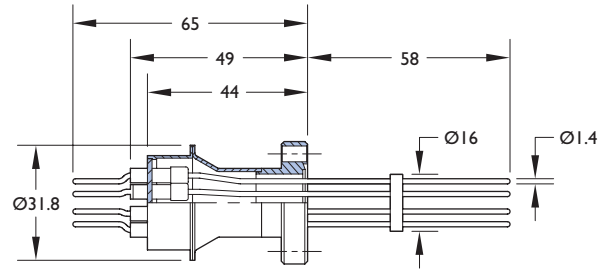

CF Mount

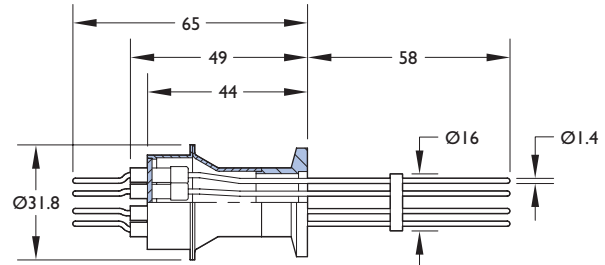

ISO KF Mount

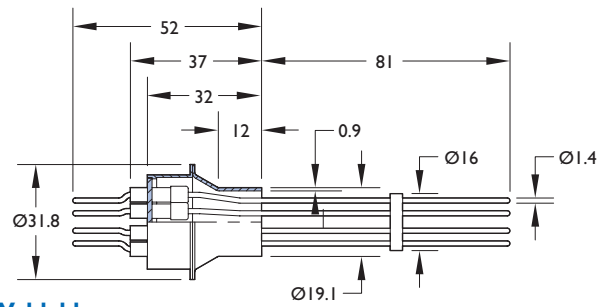

Weldable

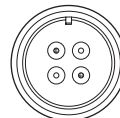

Figure 1

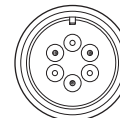

Figure 2

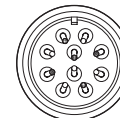

Figure 3

End view Air-side

- Polarity for TC leads is ○ for (-), and for ● (+)

All dimensions are nominal in millimetres unless specified

Thermocouple

Push-on connectors



CF



Number of pairs	Flange mount	End view figure	TC type	Reference	Part number
2	DNI6CF	1	K	MTCK-2-C16	9342006
3	DNI6CF	2	K	MTCK-3-C16	9342009
5	DNI6CF	3	K	MTCK-5-C16	9342012

Air-side connector included at no extra cost

ISO KF

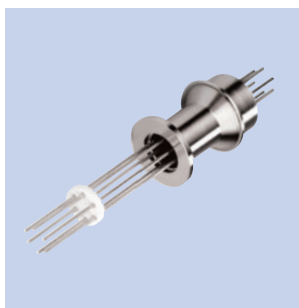

Number of pairs	Flange mount	End view figure	TC type	Reference	Part number
2	DNI6KF	1	K	MTCK-2-K16	9343002
3	DNI6KF	2	K	MTCK-3-K16	9343005
5	DNI6KF	3	K	MTCK-5-K16	9343008

Air-side connector included at no extra cost

Weldable

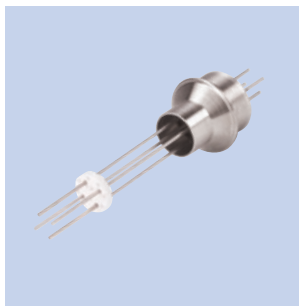

Number of pairs	End view figure	TC type	Reference	Part number
2	1	K	MTCK-2	9341002
3	2	K	MTCK-3	9341005
5	3	K	MTCK-5	9341008

Air-side connector included at no extra cost

All dimensions are nominal in millimetres unless specified

Thermocouple

TC Power

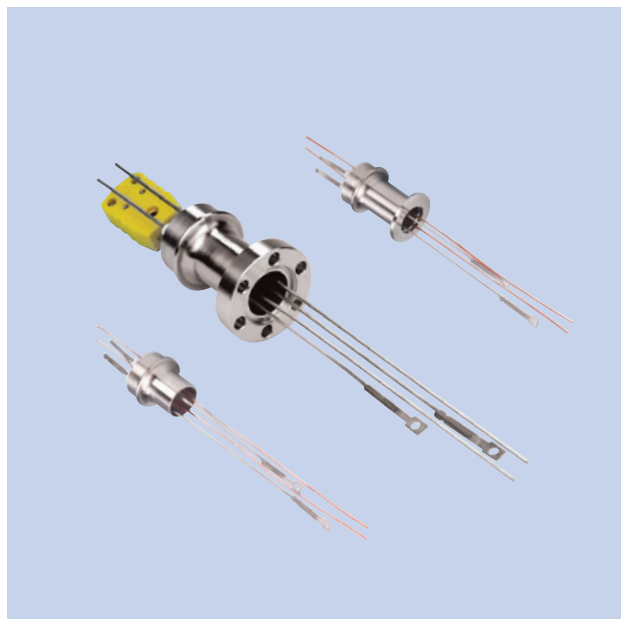

Features

- Feedthrough combines TC and Power features
- TC type K is standard – types C, E and J available upon request
- Air and vacuum-side connectors included
- In-vacuum accessories available – see section 6.7
- Three standard vacuum mounting styles
- Custom feedthrough configurations available upon request

Specifications

Voltage ¹	1,000V DC maximum
Current	See table
Material	
Flanges	304ss
Shell	304ss
Pins	See TC options
Insulation	Alumina ceramic
Vacuum range UHV	1×10^{-10} mbar
Temperature range ²	
CF Mounted feedthrough	-100°C to 450°C
Air-side connector	-65°C to 125°C
Dimensions	Reference only, subject to change

¹ See intended operating parameters in introductory section

² Overall assembly ratings must be adjusted to that of the lowest rated component

UHV and HV series

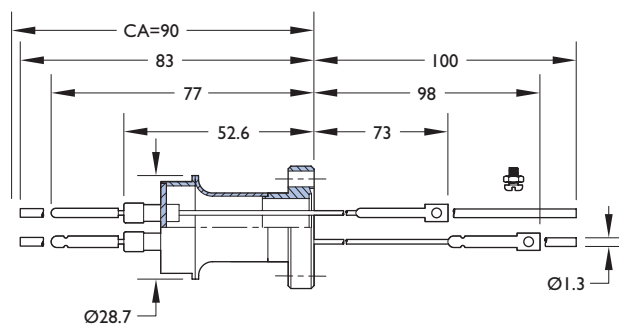

CF Mount

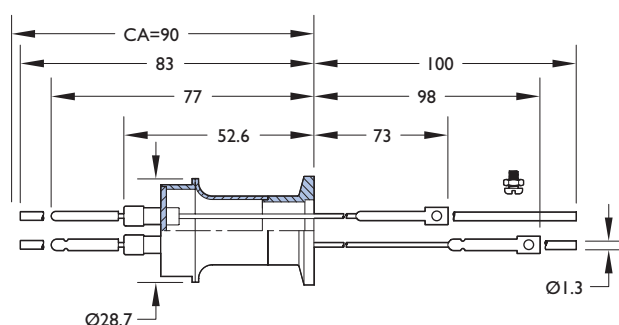

ISO KF Mount

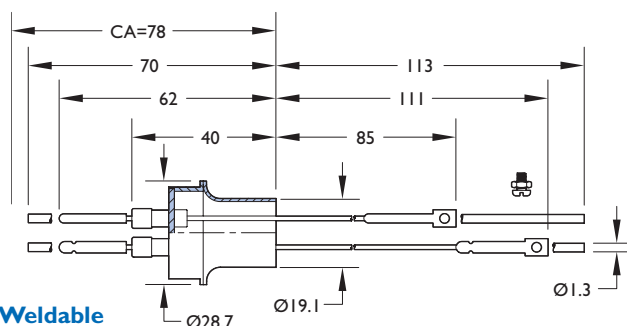

Weldable

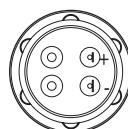

Figure 1

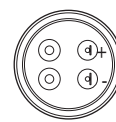

Figure 2

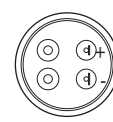
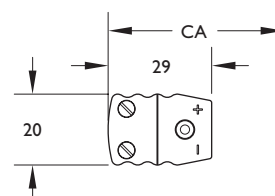

Figure 3

End view Air-side



Air-side connector

- Polarity for TC leads is (-) for longer lead and (+) for shorter lead

All dimensions are nominal in millimetres unless specified



CF



No. of TC pairs	No. of power leads	Amps	Conductor material	Flange mount	End view figure	TC type	Reference	Part number
1	2	5	Nickel	DNI6CF	1	K	TCK-5N-C16	9392003
1	2	15	Copper	DNI6CF	1	K	TCK-15C-C16	9392007

Air and vacuum-side connectors included at no extra cost

ISO KF



No. of TC pairs	No. of power leads	Amps	Conductor material	Flange mount	End view figure	TC type	Reference	Part number
1	2	5	Nickel	DNI6KF	2	K	TCK-5N-K16	9393003
1	2	15	Copper	DNI6KF	2	K	TCK-15C-K16	9393007

Air and vacuum-side connectors included at no extra cost

Weldable



No. of TC pairs	No. of power leads	Amps	Conductor material	End view figure	TC type	Reference	Part number
1	2	5	Nickel	3	K	TCK-5N	9391003
1	2	15	Copper	3	K	TCK-15C	9391007

Air and vacuum-side connectors included at no extra cost

All dimensions are nominal in millimetres unless specified

Thermocouple

TC Power



Features

- Feedthrough combines TC and Power features
- TC type K is standard – types C, E and J available upon request
- Air and vacuum-side connectors included
- In-vacuum accessories available – see section 6.7
- Three standard vacuum mounting styles
- Custom feedthrough configurations available upon request

Specifications

Voltage¹ 5,000V DC maximum

Current See table

Material

Flanges 304ss

Shell 304ss

Pins See TC options

Insulation Alumina ceramic

Vacuum range UHV/HV 1×10^{-10} mbar / 1×10^{-8} mbar

Temperature range

²

CF Mounted feedthrough -100°C to 450°C

ISO KF Mounted feedthrough -20°C to 150°C

Weldable feedthrough -100°C to 450°C

Air-side connector -65°C to 125°C

Dimensions Reference only, subject to change

¹ See intended operating parameters in introductory section

² Overall assembly ratings must be adjusted to that of the lowest rated component

UHV and HV series

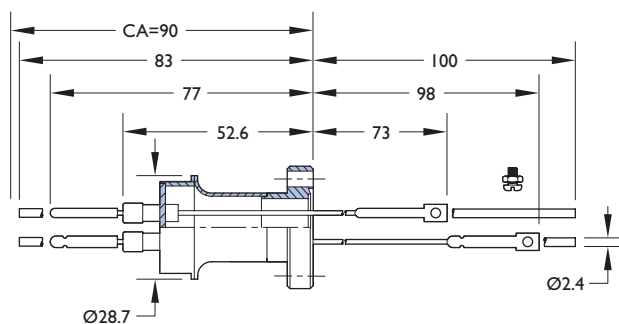

CF Mount

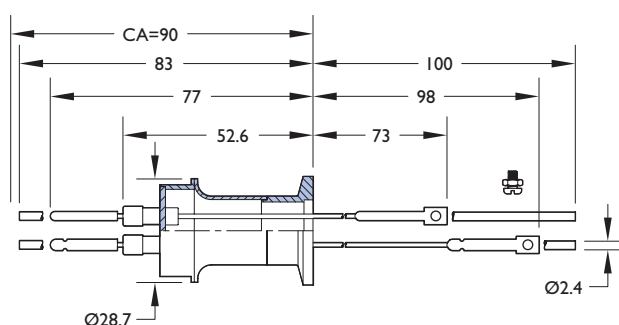

ISO KF Mount

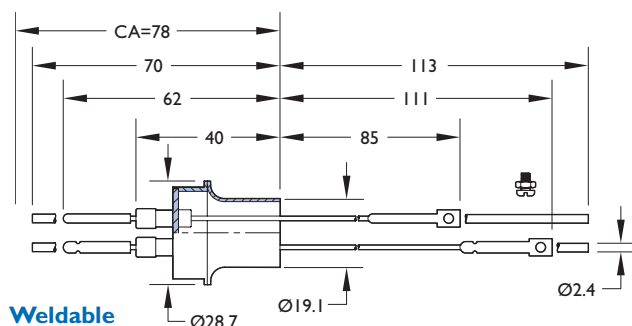

Weldable

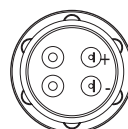

Figure 1

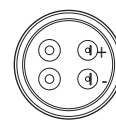

Figure 2

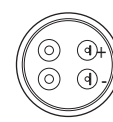
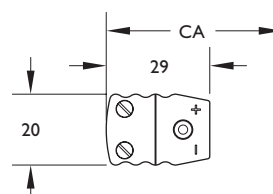

Figure 3

End view Air-side



Air-side connector

- Polarity for TC leads is (-) for longer lead and (+) for shorter lead

All dimensions are nominal in millimetres unless specified

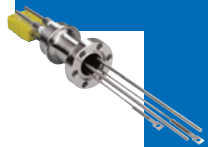

CF



No. of TC pairs	No. of power leads	Amps	Conductor material	Flange mount	End view figure	TC type	Reference	Part number
1	2	15	Nickel	DNI6CF	1	K	TCK-15N-CI6	9392011
1	2	30	Copper	DNI6CF	1	K	TCK-30C-CI6	9392015

Air and vacuum-side connectors included at no extra cost

ISO KF

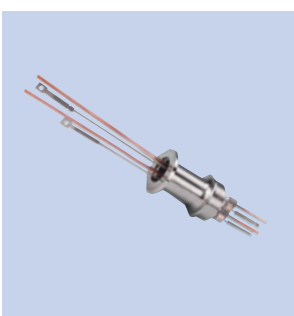

No. of TC pairs	No. of power leads	Amps	Conductor material	Flange mount	End view figure	TC type	Reference	Part number
1	2	15	Nickel	DNI6KF	2	K	TCK-15N-KI6	9393011
1	2	30	Copper	DNI6KF	2	K	TCK-30C-KI6	9393015

Air and vacuum-side connectors included at no extra cost

Weldable



No. of TC pairs	No. of power leads	Amps	Conductor material	End view figure	TC type	Reference	Part number
1	2	15	Nickel	3	K	TCK-15N	9391011
1	2	30	Copper	3	K	TCK-30C	9391015

Air and vacuum-side connectors included at no extra cost

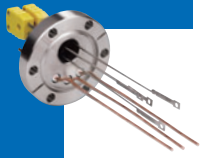

Features

- Feedthrough combines TC and Power features
- TC type K is standard – types C, E and J available upon request
- Air and vacuum-side connectors included
- In-vacuum accessories available
- Custom feedthrough configurations available upon request

Specifications

Voltage¹	5,000V DC maximum
Current	See table
Material	
Flanges	304ss
Shell	304ss
Pins	See TC options
Insulation	Alumina ceramic
Vacuum range UHV	1×10^{-10} mbar
Temperature range²	
CF Mounted feedthrough	-100°C to 450°C
Air-side connector	-65°C to 125°C

Dimensions Reference only, subject to change

¹ See intended operating parameters in introductory section

² Overall assembly ratings must be adjusted to that of the lowest rated component

UHV

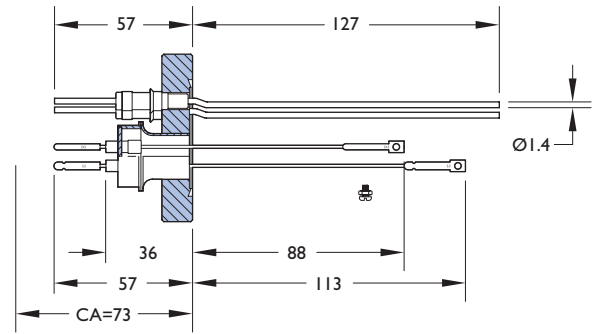

Figure 1

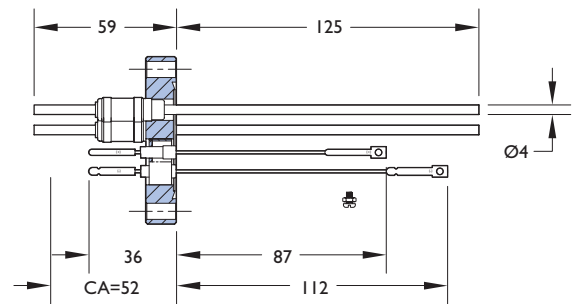

Figure 2

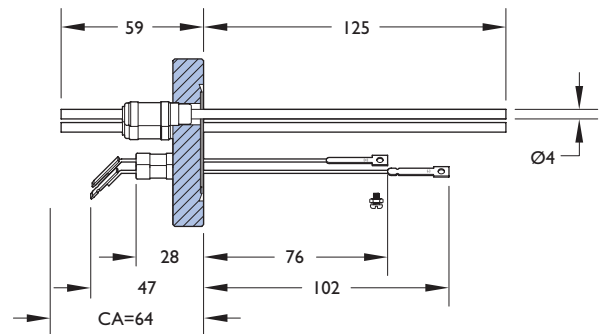
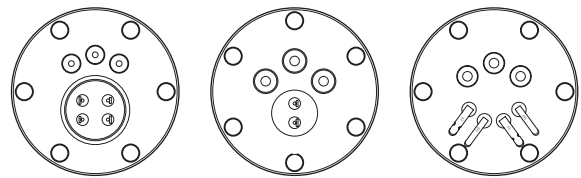
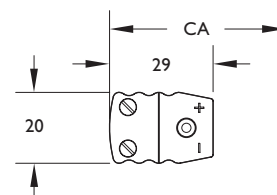

Figure 3



End view Air-side



Air-side connector

- Polarity for TC leads is (-) for longer lead and (+) for shorter lead

All dimensions are nominal in millimetres unless specified



CF



No. of TC pairs	No. of power leads	Amps	Conductor material	Flange mount	End view figure	TC type	Reference	Part number
2	3	30	Copper	DN40CF	1	K	TCK-2-30C-3-C40	9392019
1	3	60	Copper	DN40CF	2	K	TCK-60C-3-C40	9392023
2	3	60	Copper	DN40CF	3	K	TCK-2-60C-3-C40	9392035

Air and vacuum-side connectors included at no extra cost

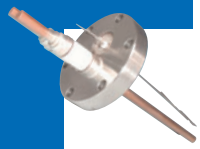

Thermocouple

TC Power

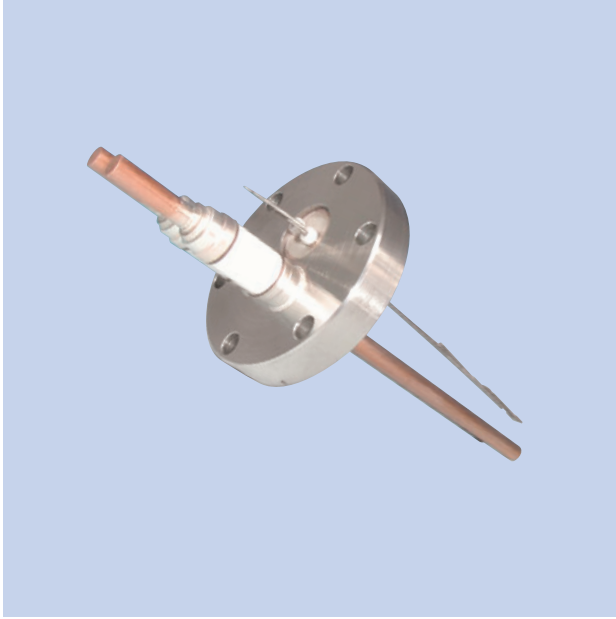

Features

- Feedthrough combines TC and Power features
- TC type K is standard – types C, E and J available upon request
- Air-side connector included
- In-vacuum accessories available – see section 6.7
- Custom feedthrough configurations available upon request

Specifications

Voltage¹	5,000V DC maximum
Current	See table
Material	
Flanges	304ss
Shell	304ss
Pins	See TC options
Insulation	Alumina ceramic
Vacuum range UHV	1x10 ⁻¹⁰ mbar
Temperature range²	
CF Mounted feedthrough	-100°C to 450°C
Air-side connector	-65°C to 125°C

Dimensions Reference only, subject to change

¹ See intended operating parameters in introductory section

² Overall assembly ratings must be adjusted to that of the lowest rated component

UHV

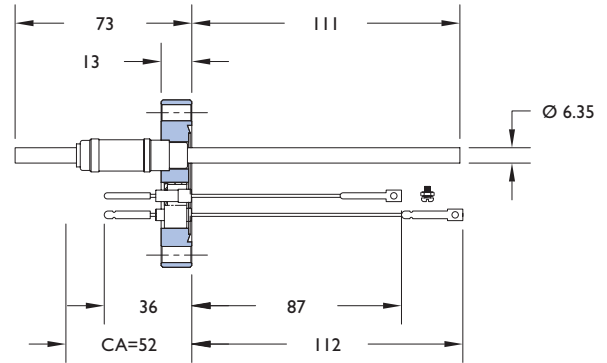

Item 1

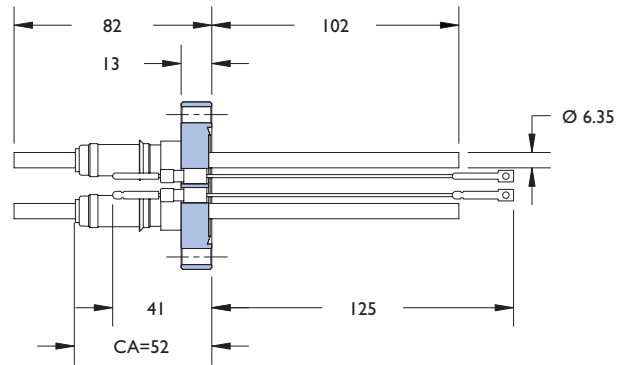

Item 2

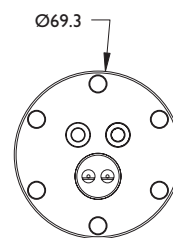

Figure 1

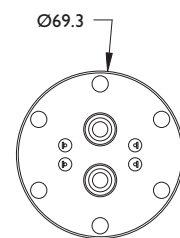
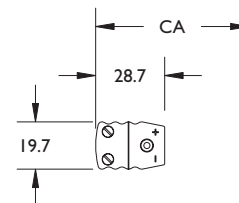

Figure 2

End view Air-side



Air-side connector

- Polarity for TC leads is (-) for longer lead and (+) for shorter lead

All dimensions are nominal in millimetres unless specified. Weights given are approximate.



CF

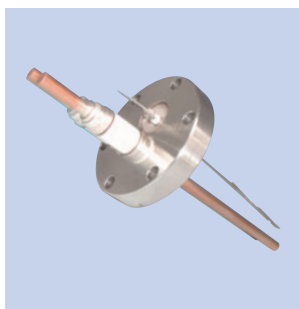

No. of TC pairs	No. of power leads	Amps	Conductor material	Flange mount	End view figure	TC type	Reference	Part number
1	2	150	Copper	DN40CF	1	K	TCK-150C-C40	9392027
2	2	150	Copper	DN40CF	2	K	TCK-150-2-C40	9392031

Air and vacuum-side connectors included at no extra cost

Power feedthroughs

Introduction

Power is the classification Caburn-MDC gives to electrical feedthroughs used to carry either high voltage or high current, or both. The majority of feedthroughs in this section are built with exposed conductors on both the air and vacuum-sides. Air and vacuum-side connectors are available for most products in this section and must be purchased separately unless noted otherwise.

Caburn-MDC power feedthroughs are used in a multitude of applications including vacuum furnaces, sample heating, biasing and in-vacuum coating applications such as electron beam evaporation, resistive heating evaporation and DC plasma sputtering.

Power feedthrough electrical ratings are determined by various factors, including insulator dielectric strength, geometry and system operating pressure. Please note that all Caburn-MDC catalogue products are electrically rated for operation with one side in dry atmospheric conditions and the other side in vacuum with a maximum system pressure of 1×10^{-4} mbar. We advise that users make allowances for deviations from stated operating parameters and take adequate safety precautions when feedthroughs are operated at high voltages or high currents.

Strike, puncture and creep

Strike, puncture and creep are three industry terms used to describe electrical failure and rating criteria.

Strike distance is the direct line of site distance from potential to ground. This rating is dependent on environmental and overall feedthrough geometry.

Puncture distance is the distance between potential and ground through the bulk of the ceramic insulating material. This rating is dependent on both the dielectric strength of the ceramic and its geometry.

Creep or tracking distance is the distance from potential to ground along a ceramic insulator's surface path. This rating is dependent on environment as well as the surface condition and overall length.

Electrical performance

Proven design techniques are employed to optimize the electrical performance of Caburn-MDC power feedthroughs. Where space is not a limitation, ceramic surfaces are made as long as possible to maximize strike and creep distances. If space is limited, ceramics are convoluted to achieve increased surface distance with minimal impact on the overall length. Convoluted or fluted ceramic feedthroughs are recommended for environments where moisture or other surface contaminants may hinder

electrical performance. Reducing the ceramic surface roughness will minimize surface contamination and thus improve the tracking characteristics of the feedthrough.

A common method used to reduce surface roughness is the application of high temperature glass coating, or 'glazing'. Glazing is a proven and cost effective method for enhancing the electrical performance of a ceramic.

Water-cooled feedthroughs

Water-cooled electrical components are typically used with grounded, closed-loop cooling systems and non-conductive coolants such as de-ionized

water or ethylene glycol. If using plain tap water, the cooling system must be grounded and lines must employ non-conductive materials such as polypropylene tubing. Properly grounded water lines will provide a safe dissipation path for any power conducted by the water. Current or power ratings are usually not given for water-cooled feedthroughs as the ratings are dependent on coolant flow rates and their heat dissipating capacity. Tap water temperatures can vary dramatically from one region to another, so too will its heat dissipating capacity. Users are advised to establish safe and practical coolant flow rates based on the power requirements for their specific application and coolant heat dissipation capacity.



Part numbers printed in a light blue colour indicate products that are suitable for -200 C cryogenic applications.

Intended operating conditions

Electrical ratings are safe operating limits. These ratings are determined by various factors, including dielectric strength, geometry and system operating pressure. Please note that all Caburn-MDC catalogue products are electrically rated for operation with one side in dry atmospheric conditions and the other side in a vacuum environment with a maximum system pressure of 1×10^{-4} mbar. We advise that users make allowances for deviations from stated operating parameters and take adequate safety precautions when feedthroughs are operated at high voltages or high currents.

UHV and HV series

Caburn-MDC offers three standard vacuum mount styles: CF, ISO KF and weldable. Additional configurations are available upon request.

All dimensions are nominal in millimetres unless specified